









# VUE D'ENSEMBLE DE L'ASSORTIMENT DE VARIATEURS

\* Selon l'outil DIMM de Feller: [www.feller.ch/dimtool](http://www.feller.ch/dimtool)

	Variateur universel (RLC)			Par commande de phase (RL)		Par interruption de phase (RC)		Variateur 1-10V	Variateur DALI
	 NOUVEAU								
Symbole	Variateur rotatif	Variateur rotatif	Variateur rotatif	Variateur rotatif	Variateur rotatif	Variateur rotatif	Variateur rotatif	Variateur rotatif	Variateur rotatif
Illuminable avec LED	●	●	●	●	-	●	●	-	-
Puissance	4-400W	20-420W/VA	20-600W/VA	40-600W	60-1000W	20-300VA	20-600VA	1-10 V max. 600VA	justqu'à 25 BE
Fusible électronique	●	●	●	-	●	●	●	-	●
Réglage min.	●	●	●	●	●	●	●	●	●
Réglage max.	●	●	●	-	-	-	-	●	●
Schéma 3	●	●	●	●	-	●	●	-	-

## EDIZIOdue, appareils complets blancs, lumineux (.xx voir «Aperçu des couleurs LED»)

Code Feller	40200.LED.FMI.61.xx	40420.RLC.FMI.61.xx	40600.RLC.FMI.61.xx	40600.RL.FMI.61.xx	-	40300.RC.FMI.61.xx	40600.RC.FMI.61.xx	-	-
E-No	E No 548 832 6xx	E No 548 250 6xx	E No 548 240 6xx	E No 548 260 6xx	-	E No 548 290 6xx	E No 548 270 6xx	-	-

pour toutes les autres couleurs, système modulaire lumineux

Code Feller	40200.LED.BSM.xx	40420.RLC.BSM.xx	40600.RLC.BSM.xx	40600.RL.BSM.xx	-	40300.RC.BSM.xx	40600.RC.BSM.xx	-	-
E-No	E No 548 833 7xx	E No 548 253 7xx	E No 548 243 7xx	E No 548 263 7xx	-	E No 548 293 7xx	E No 548 273 7xx	-	-

## EDIZIOdue, appareils complets blancs, non lumineux

Code Feller	40200.LED.FMI.61	40420.RLC.FMI.61	40600.RLC.FMI.61	40600.RL.FMI.61	31000.FMI.61	40300.RC.FMI.61	40600.RC.FMI.61	40600.1-10V.FMI.61	40080.FMI.61
E-No	E No 548 832 000	E No 548 250 000	E No 548 240 000	E No 548 260 000	E No 548 732 000	E No 548 290 000	E No 548 270 000	E No 548 280 000	E No 548 502 000









## Standard, appareil complet blanc, non lumineux

Code Feller	40200.LED.PMI.61	40420.RLC.PMI.61	40600.RLC.PMI.61	40600.RL.PMI.61	31000.PMI.61	40300.RC.PMI.61	40600.RC.PMI.61	40600.1-10V.PMI.61	40080.PMI.61
E-No	E No 348 836 000	E No 348 250 000	E No 348 240 000	E No 348 260 000	E No 348 730 000	E No 348 290 000	E No 348 270 000	E No 348 280 000	E No 348 609 000

## FLF, appareil complet blanc, non lumineux

Code Feller	40200.LED.FLF.6/5.61	40420.RLC.FLF.6/5.61	40600.RLC.FLF.6/5.61	40600.RL.FLF.6/5.61	31000.FLF.6/5.61	40300.RC.FLF.6/5.61	40600.RC.FLF.6/5.61	40600.1-10V.FLF.6/5.61	40080.FLF.6/5.61
E-No	E No 428 832 000	E No 428 675 000	E No 428 676 000	E No 428 672 000	E No 428 652 000	E No 428 674 000	E No 428 673 000	E No 428 620 000	E No 428 609 000

## Charge/Consommateur

Charge								-	-
R 	●	●	●	●	●	●	●	-	-
L 	●	●	●	●	●	-	-	-	-
C 	●	●	●	-	-	●	●	-	-
avec BE 	-	-	-	-	-	-	-	● avec BE pour 1-10V	● avec BE DALI
avec LED	●*	●*	●*	●*	●*	●*	●*	-	-

Exemple:  
Variateur rotatif universel LED  
EDIZIOdue 400 VA sand  
avec LED blanche

Utilisation du système modulaire lumineux, blanc (14)



40200.LED.BSM.14  
548 833 700



Set de recouvrement lumineux, sand (36)







920-40000.FMI.SL.36  
378 343 810



Appareil complet lumineux



## Explication des symboles

-  Lampes halogènes haute tension (HT) et lampes à incandescence à charge ohmique
-  Lampes halogènes basse tension (BT) avec transformateur enroulé et charge inductive
-  Lampes halogènes basse tension (BT) avec transformateur électronique et charge capacitive
-  Lampes LED

## Précision

En raison de normes insuffisantes, Feller ne peut pas garantir le bon fonctionnement de lampes LED ou économiques réglables. Feller décline toute responsabilité en cas de dommage au variateur ou à la lampe.

Veillez consulter l'outil DIMM de Feller sur [www.feller.ch/dimtool](http://www.feller.ch/dimtool).

Les prises ne doivent pas être alimentées par un variateur!

## Aperçu des couleurs LED

	Code Feller	Code E
bleu	..74	..70
blanc	..14	..00
jaune	..34	..80
rouge	..44	..50
vert	..84	..60

## Mise en place de l'élément d'éclairage

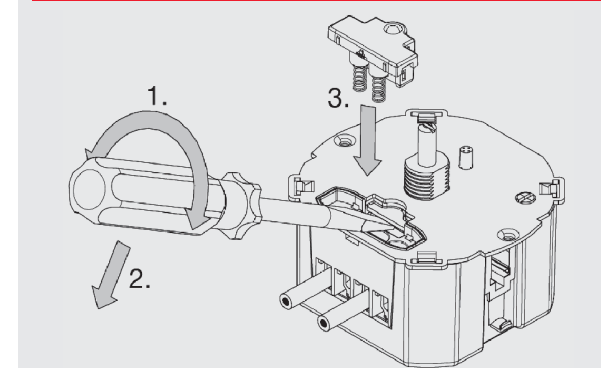

## Aperçu des éléments d'éclairage LED

	Code Feller	Code E
bleu	660.230V.LED.70	209 990 670
blanc	660.230V.LED.10	209 990 600
jaune	660.230V.LED.30	209 990 680
rouge	660.230V.LED.40	209 990 650
vert	660.230V.LED.80	209 990 660

## Aperçu des sets de recouvrement lumineux

	Code Feller	Code E
blanc	920-40000.FMI.SL.61	378343000
silver	920-40000.FMI.SL.08	378343840
gris clair	920-40000.FMI.SL.65	378343030
gris foncé	920-40000.FMI.SL.67	378343040
noir	920-40000.FMI.SL.60	378343950
vanille	920-40000.FMI.SL.37	378343080
crema	920-40000.FMI.SL.35	378343010
sand	920-40000.FMI.SL.36	378343810
coffee	920-40000.FMI.SL.57	378343890
lemon	920-40000.FMI.SL.88	378343860
olive	920-40000.FMI.SL.80	378343850
berry	920-40000.FMI.SL.41	378343800

**Feller**  
by Schneider Electric

Feller AG | Postfach 1 CH-8810 Horgen  
Téléphone +41 44 728 72 72 | Téléfax +41 44 728 72 99 | [www.feller.ch](http://www.feller.ch)

Feller SA | Agence Suisse Romande | Caudray 6 | CH-1020 Renens  
Téléphone +41 21 653 24 45 | Téléfax +41 21 653 24 51

69\_DIMMERUEB-F.1504