

Application description

Dimming actuator

1 fold: 36371-1.REG

2fold: 36372-2.REG

4fold: 36374-4.REG

10.KNX36371-E.1601

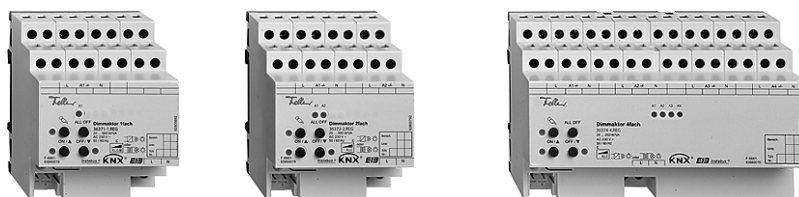

All rights reserved, including translation into other languages. It is not permitted to copy, duplicate or distribute the document or parts thereof in any form or to transmit it by means of electronic systems without the written consent of the publisher.
We reserve the right to make technical changes..

Table of Contents

1	Product definition	4
1.1	Product catalogue	4
1.2	Function	4
2	Installation, electrical connection and operation	6
2.1	Safety instructions	6
2.2	Device components	7
2.3	Fitting and electrical connection	9
2.4	Commissioning	16
2.5	Operation	19
2.5.1	Manual operation on device	19
2.5.2	Behaviour in the event of problems with the load	23
3	Technical data	28
4	Software description	31
4.1	Software specification	31
4.2	Software "Dimming actuator"	33
4.2.1	Scope of functions	33
4.2.2	Notes on software	34
4.2.3	Object table	36
4.2.4	Functional description	44
4.2.4.1	Description of channel-independent functions	44
4.2.4.1.1	Channel definition	44
4.2.4.1.2	Manual operation	46
4.2.4.1.3	Delay after device reset	50
4.2.4.1.4	Central function	51
4.2.4.2	Channel-oriented functional description	52
4.2.4.2.1	Definition of the operating mode	52
4.2.4.2.2	Definition of the load type and load type message	53
4.2.4.2.3	Signalling short-circuit	57
4.2.4.2.4	Signalling load failure / overload	58
4.2.4.2.5	Definition of the brightness range	60
4.2.4.2.6	Response after a device reset	64
4.2.4.2.7	Feedback for switching status and brightness value	67
4.2.4.2.8	Timing functions	73
4.2.4.2.9	Soft ON/OFF function	75
4.2.4.2.10	Automatic switch-off	78
4.2.4.2.11	Staircase function / Time dimmer function	81
4.2.4.2.12	Light scene function	91
4.2.4.2.13	Operating hours counter	95
4.2.4.2.14	Supplementary function	99
4.2.4.2.15	Dimming characteristic, dimming behaviour and dimming speeds	105
4.2.4.2.16	Special features of the speed controller operating mode	112
4.2.4.3	Delivery state	115
4.2.5	Parameters	116

5 Appendix 150
5.1 Index 150

1 Product definition

1.1 Product catalogue

Product name: Dimming actuator 1fold, REG / Dimming actuator 2fold, REG / Dimming actuator 4fold, REG

Use: Actuator

Design: Rail-mounted device

Order No. 36371-1.REG / 36372-2.REG / 36374-4.REG

1.2 Function

The universal dimmer actuator works according to the leading edge phase control or trailing edge phase control dimming principle and makes switching and dimming of HV incandescent lamps, HV halogen lamps and LV halogen lamps with inductive transformers or Tronic-Transformers possible by means of conventional transformers and Tronic-Transformers. It is also possible to activate dimmable HV-LEDs or compact fluorescent lamps. If, in the ETS, Version "1.3" of the application program is used in combination with devices of the "V04" generation or higher, then LV-LEDs can also be activated via electronic or conventional transformers.

The characteristic of the connected load - provided that the load is supported - can be automatically measured separately for each output channel and the appropriate dimming procedure can be set. Alternatively, it is possible to predefine the dimming procedure using the ETS configuration. This procedure is necessary for loads that do not enable automatic calibration (e.g. with compact fluorescent lamps).

There are up to 4 dimming channels available depending on the device variants. To simplify the configuration, all existing dimming channels can be assigned to the same parameters in the ETS and thus configured identically. The number of parameters is thereby reduced in the ETS and applied automatically on all channels.

To increase the channel power, the device variant "4-gang" can be wired in parallel by reducing the number of channel outputs (not with HV/LV-LED lamps or compact fluorescent lamps). The assignment of parallel to wired dimming outputs to the KNX-controllable dimming channels takes place in the ETS.

The device permits the separate feedback of the individual switching and brightness statuses of the connected loads to the KNX. Moreover, a short-circuit and load failure can be signalled separately to the KNX for each dimming channel.

The operating elements (4 pushbuttons) on the front panel of the device allow the dimming channels to be switched on or dimmed by manual operation in parallel with the KNX even without bus voltage or in a non-programmed state. This feature permits fast checking of connected loads for proper functioning.

For project design and commissioning of the device, ETS3.0 from Version "d" onwards, ETS4.1 or more recent or ETS5 is required. The advantages with regard to downloading (shorter loading times) are available only if this ETS versions are used.

The function features that are independently adjustable for every dimming channel by means of the ETS include, for example, separately configurable brightness ranges, extended feedback functions, a disabling function, or alternatively, a forced position function, a logic operation function, separately adjustable dimming behaviour, soft dimming functions, time delays and a staircase function with pre-warning before switching off the lighting.

Furthermore, each dimming channel can be integrated in up to 8 scenes with various brightness values. Central switching of all channels is possible, too. Moreover, the brightness values of the dimming channels in case of bus voltage failure or bus voltage return and after ETS programming, can be preset separately.

The switch-on times of the dimming channels can be detected and evaluated separately by operating hours counters.

Apart from controlling lighting, the universal dimmer actuator 1-gang can be used as a speed controller of single-phase electric motors. This operating mode can be preselected in the ETS and has an effect on the parameter configuration and function of the device.

The device has a mains voltage connection that is independent of the load outputs for supplying the device electronics of the manual operation and integrated bus coupling unit. The device electronics and bus coupling unit are also supplied from the bus coupling unit so that an ETS programming operation or manual operation is also possible even if the mains voltage is not connected or is switched off. As long as the bus voltage is connected and ready for operation, the device's internal power supply unit is switched off to save energy.

The load outputs have separate mains voltage connections for supplying the digital dimmer packs and the connected load.

The device is designed for mounting on DIN-rails in closed compact boxes or in power distributors in fixed installations in dry rooms.

i Different device generations and application program versions are available thus resulting in functional differences - particularly with regard to the activation of HV-LED lamps and LV-LED lamps. It is possible to distinguish between the application programs and device generations by means of the version designation . (see page 34-35).

This product documentation describes the scope of functions of all application programs and device generations and will deal with the functional differences at the appropriate places if necessary.

2 Installation, electrical connection and operation

2.1 Safety instructions

Electrical equipment may only be installed and fitted by electrically skilled persons. The applicable accident prevention regulations must be observed.

Failure to observe the instructions may cause damage to the device and result in fire and other hazards.

Danger of electric shock. Device is not suitable for disconnection from supply voltage. The load is not electrically isolated from the mains even when the device is switched off.

Danger of electric shock. Before working on the device or before exchanging light bulbs, disconnect mains voltage. At the same time, take into account all circuit breakers that supply dangerous voltage to the device or load.

Only with application program version "1.2" and device generations "V02" and "V03": Do not connect any HV-LED or compact fluorescent lamps that are not specifically suitable for dimming. Device can be damaged.

Only with application program version "1.3" and device generations "V04" and higher: Do not connect any HV-LED, NV-LED (via Tronic transformer or conv. transformer) or compact fluorescent lamps that are not specifically suitable for dimming. Device can be damaged.

Do not connect any lights with integrated dimmers.

Do not connect any three-phase motors.

For operation with inductive transformers, each transformer must be fused on the primary side in accordance with the manufacturer's instructions. Only safety transformers according to EN 61558-2-6 may be used.

When extending the load range of an output, only use suitable power extensions. Choose power extensions that are suitable for the dimmer and load! For additional information, please refer to the instructions for the power extensions in question.

Make sure during the installation that there is always sufficient insulation between the mains voltage and the bus. A minimum distance of at least 4 mm must be maintained between bus conductors and mains voltage cores.

Do not open device or operate it beyond the technical specification.

2.2 Device components

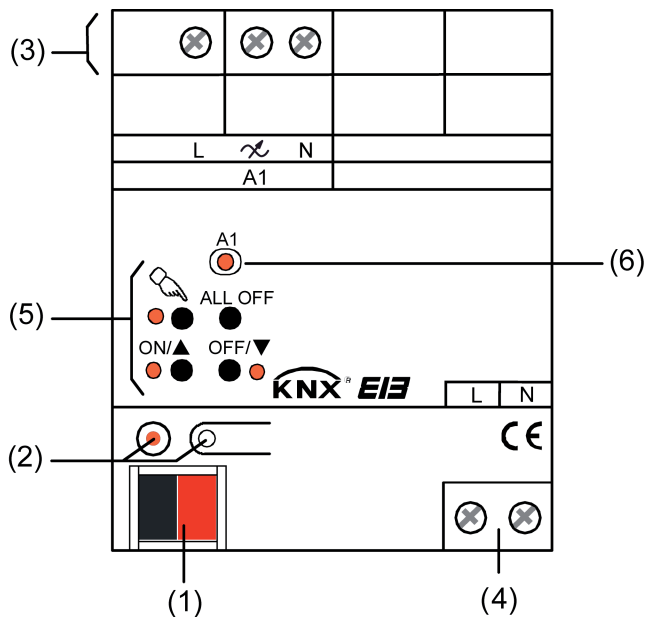

Figure 1: Structure of the 1-gang display variant

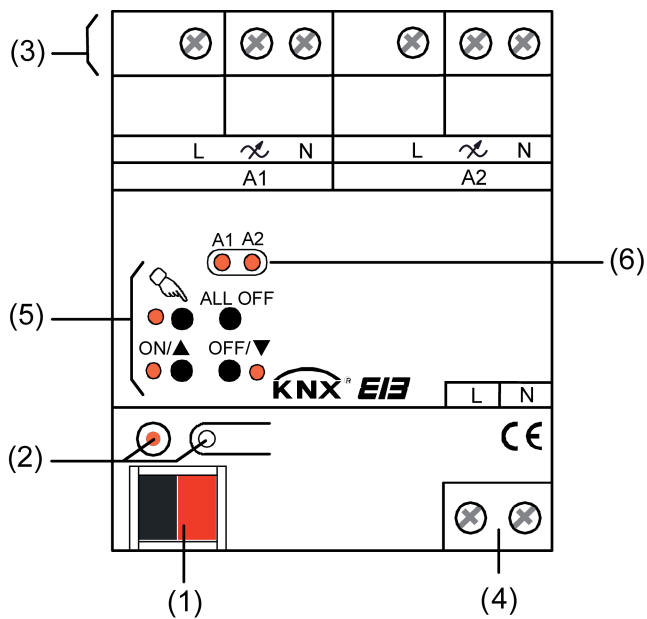

Figure 2: Structure of the 2-gang display variant

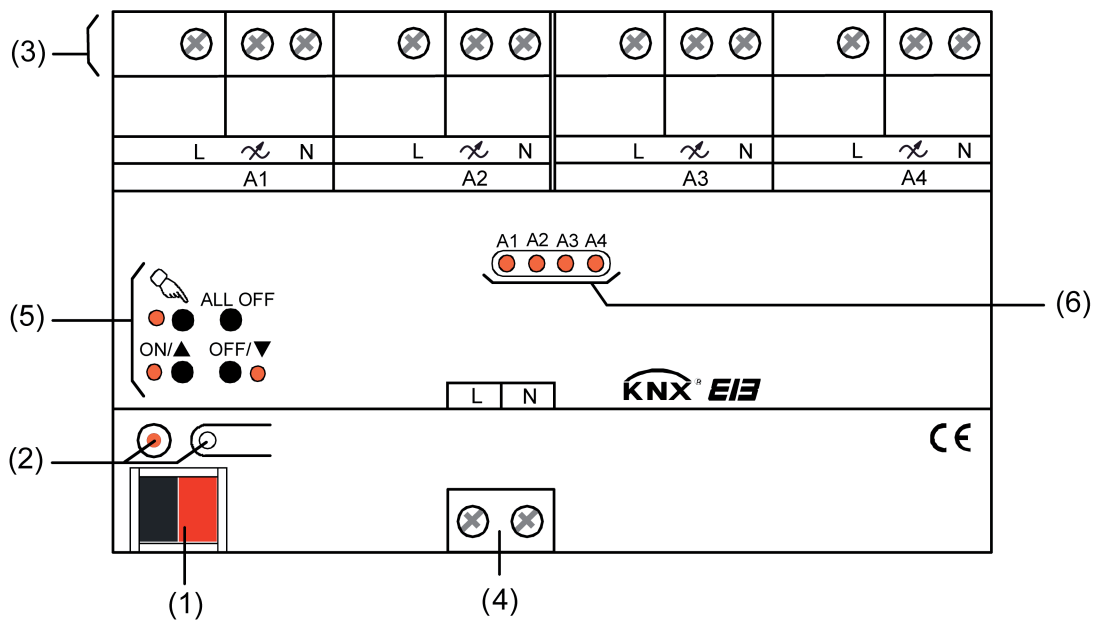

Figure 3: Structure of the 4-gang display variant

- (1) KNX bus connection
- (2) Programming button and programming LED (red).
- (3) Screw terminals (L, \sim , N) for connection of the load (connection of mains voltage and dimmer outputs).
- (4) Screw terminals (L, N) for connection of the mains voltage (device power supply).
- (5) Button field for manual control with status LEDs (red)
- (6) Status LEDs (red) of the outputs.
 LED off: output switched off
 LED on: output switched on
 LED flashing slowly: output in manual control
 LED flashing quickly: output blocked by manual control

2.3 Fitting and electrical connection

**DANGER!****Electrical shock when live parts are touched.****Electrical shocks can be fatal.****Before working on the device, disconnect the power supply and cover up live parts in the working environment.**

Fitting the device

- Fit the device by snapping it onto a DIN-rail in acc. with EN 60715. The screw terminals for the load connection should be at the top.
- i** A KNX data rail is not required.
- i** Observe the temperature range and ensure sufficient cooling, if necessary.
- i** Maintain a distance of 1 module, approx. 18 mm, between the devices when operating multiple dimmers or power boosters within a sub-division in order to avoid overheating.

Connecting the power supply for the device electronics and load

Note permitted loads.

Observe the technical connection conditions of the electric power company.

Do not exceed permissible total load including transformer power dissipation.

Operate inductive transformers with at least 85% nominal load.

For mixed loads with inductive transformers at an output: ohmic load max. 50%.

Trouble-free operation is only ensured with electronic transformers manufactured by us or with inductive transformers.

**CAUTION!****Danger of destruction from mixed loads.****The dimmer and load may be destroyed.****Do not connect capacitive loads, e.g. electronic transformers, and inductive loads, e.g. inductive transformers, together on the same dimmer output.****Do not connect inductive transformers together with HV LED lamps or compact fluorescent lamps on the same dimmer output.**

- Connect the bus, the connection of the power supply and the load according to the connection diagram.(Figure 4).
- Do not switch on the mains voltage yet! First carry out the commissioning (see page 16).

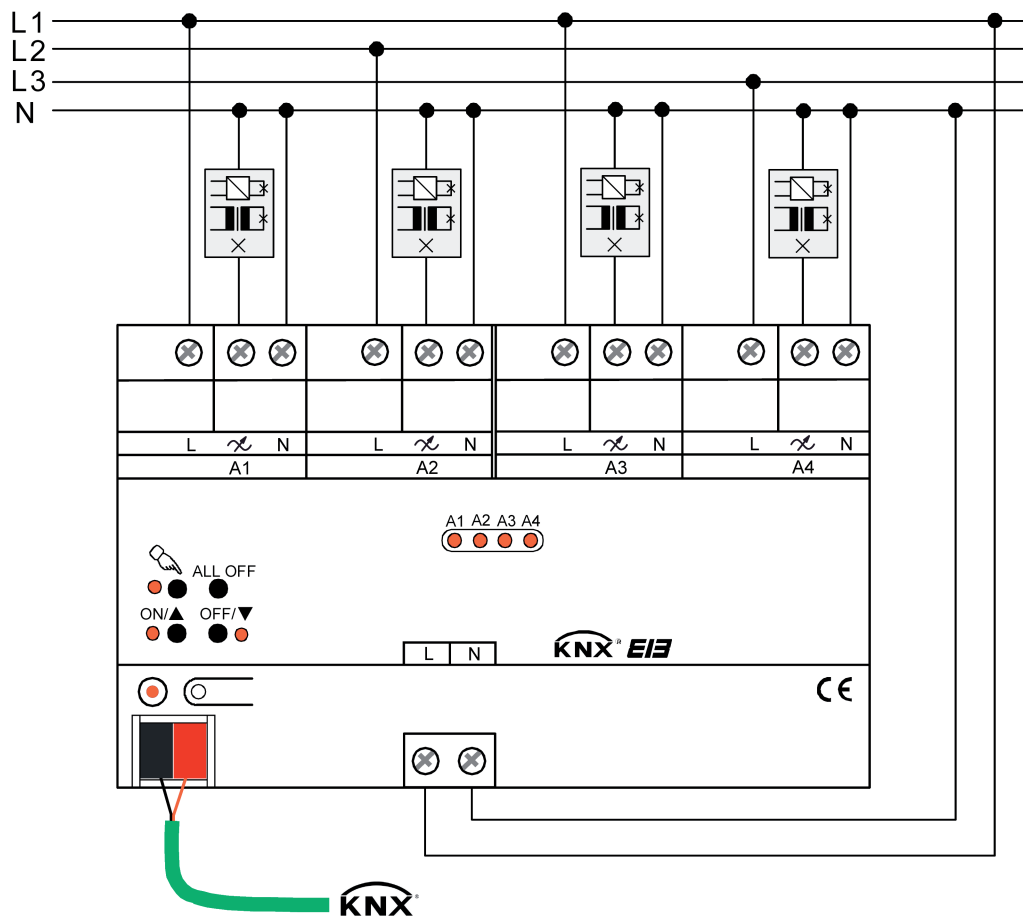

Figure 4: Electrical connection (using the example of the 4gang display variant)

- i** The supply of the load outputs and mains voltage of the device (terminals "L") can be connected to various conductors (L1, L2, L3).
- i** The N terminals for supplying the load outputs (connection required!) are not bridged in the device. Hence, different FI electric circuits can be connected to the device.
- i** Power extension possible by means of our own power boosters. Do not connect any LED lamps or compact fluorescent lamps in combination with power boosters. If the output power is increased by means of universal power boosters, the configuration of the corresponding channel must be adapted in the ETS (see parameter "Operation with universal power booster ?").
- i** Flickering of the connected lamps due to undershoot of the specified minimum load or through centralised pulses from the power stations. This does not represent any defect in the device.
- i** If the dimming principle should or cannot be universally calibrated, it must be adapted to the connected load (ETS parameter). In the as-delivered state, the load type is set to "universal" for all channels.
- i** Only with program version "1.2" and device generations "V02" and "V03": When connecting dimmable HV-LED and compact fluorescent lamps, the load type that is suitable for this purpose (parameter setting: "LED...") must always be configured in the ETS. Before switching on the mains voltage, commissioning using the ETS is essential in this case (see page 16-17).

- i** Only with program version "1.3" and device generations from "V04" and onwards:
When connecting dimmable and compact fluorescent lamps, the load type that is suitable for this purpose (parameter setting: "HV-LED...") must always be configured in the ETS. Before switching on the mains voltage, commissioning using the ETS is essential in this case (see page 16-17).
When connecting dimmable HV-LED or LV-LED lamps (with Tronic transformers or conv. transformers), you can choose between the universal dimming principle (as-delivered state) or, alternately, a suitable load type. Observe the lamp manufacturer's instructions.
- i** Only connect LED lamps and compact fluorescent lamps of one manufacturer and of the same type to a dimming output. Do not connect any other loads.
- i** Dimming results and dimming quality could vary depending on cable lengths, grid conditions and other influencing factors. Depending on the design and power rating of the lamps, the connected load of the specified values could vary. We do not assume any responsibility for the function, dimming results and dimming quality in connection with HV LED and LV LED and will not accept any liability.

Wire outputs in parallel (only for device variant "4-gang")

To increase the channel power, the device variant "4-gang" can be wired in parallel by reducing the number of channel outputs. The assignment of parallel to wired dimming outputs to the KNX-controllable dimming channels takes place in the ETS. By combining all 4 dimming outputs, the connected load can thereby be increased to a max. of 950 Watt.



CAUTION!

Risk of destruction if a wrong channel effect is configured for parallel wiring of outputs in the ETS.

The dimmer and load may be destroyed.

In the case of parallel switched outputs, check the parameter settings and adjust if necessary before switching on the mains voltage.



CAUTION!

Danger of destruction. 400 V are shorted when outputs switched in parallel are connected to different outer conductors.

The device will be destroyed.

Always connect outputs switched in parallel to the same outer conductor.

- Wire the corresponding outputs in parallel according to connection diagram (Figure 5).
- Do not switch on the mains voltage yet! First carry out the commissioning (see page 16).

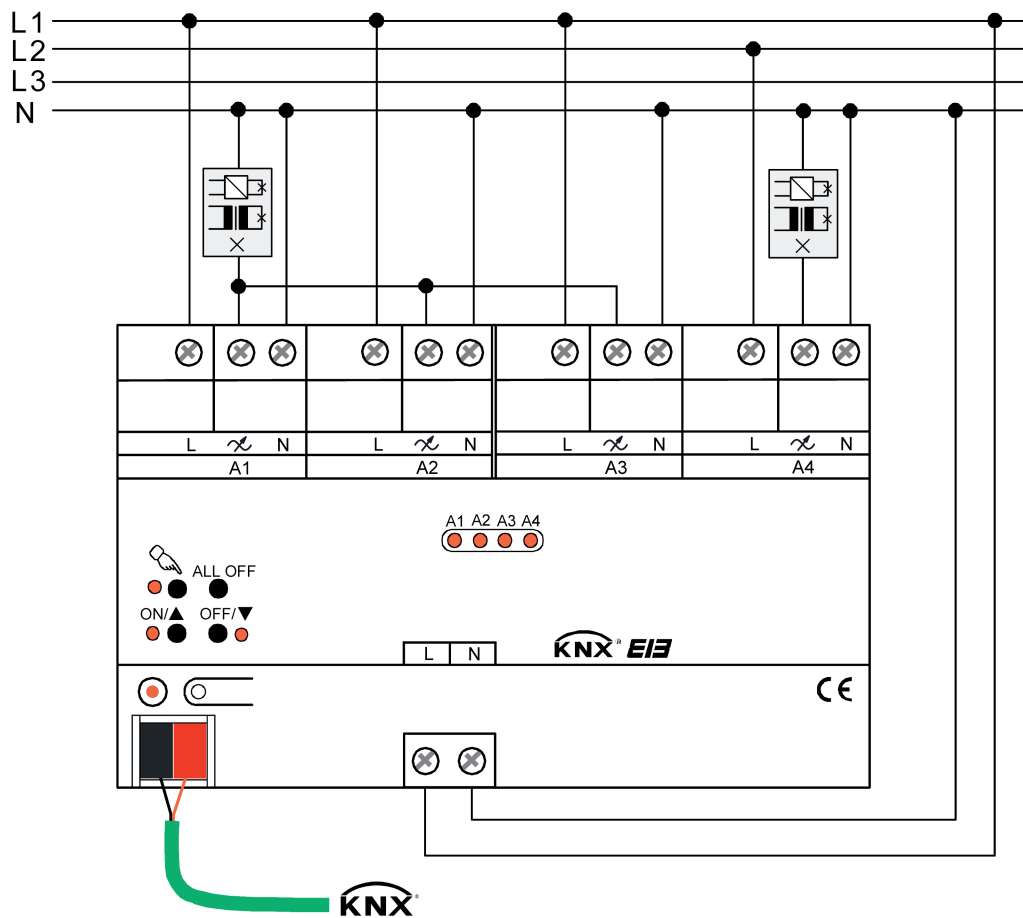

Figure 5: Electrical connection for parallel wiring of outputs (example)

- i** The L terminals of the parallel wired outputs must be connected to the same outer conductor!
- i** Parallel wired outputs can only be utilized up to a max of 95 % each.
 -> 2 outputs in parallel: Maximum connected load 475 W!
 -> 3 outputs in parallel: Maximum connected load approx. 710 W!
 -> 4 outputs in parallel: Maximum connected load 950 W!
- i** In the case of parallel wiring of dimming outputs, it is not permitted to connect additional power extensions to the load outputs concerned!
- i** Do not connect any HV-LED, LV-LED (via Tronic transformers or conventional transformers) or compact fluorescent lamps to dimmer outputs switched in parallel.
- i** With the "2-gang" device variant the dimming outputs cannot be wired in parallel.

Connecting motors (only for "1-gang" device variant)

Apart from controlling lighting, the universal dimmer actuator 1-gang can be used as a speed controller of single-phase electric motors. This operating mode can be preselected in the ETS and has a considerable effect on the parameter configuration and function of the device.

**CAUTION!**

Risk of destruction if a wrong operating mode is configured in the ETS when connecting motors.

The dimmer and motor load may be destroyed.

When connecting motors, check the parameter settings and adjust if necessary before switching on the mains voltage.

- Connect single-phase electric motors according to connection diagram (Figure 6).
- Do not switch on the mains voltage yet! First carry out the commissioning (see page 16).

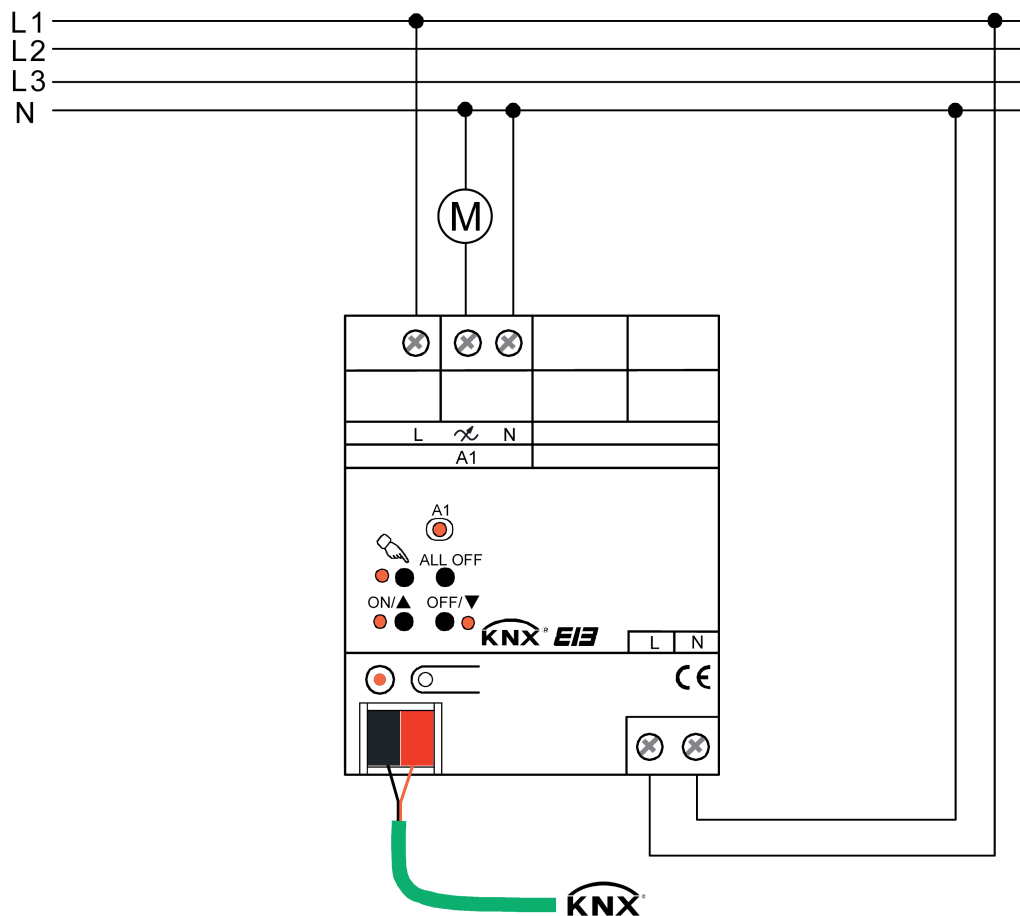

Figure 6: Electrical connection of single-phase electric motors

- i** Do not connect any three-phase motors!
- i** When connecting several motors in parallel, observe the maximum output power of the device! Only connect motors of identical type in parallel!
- i** With the operating mode "speed controller", it is not permitted to connect additional power extensions to the power output!
- i** In the as-delivered state of the device, the "lighting control" is preconfigured as operating mode. When connecting a motor, the "speed controller" operating mode must be configured in the ETS.
Before switching on the mains voltage, commissioning using the ETS is essential (see chapter 2.4. Commissioning).

Changing connected load type

If one of the connected loads is changed after the commissioning, another load type can also result due to the load change - for example, when replacing a ceiling luminaire with an incandescent lamp by a low voltage illuminant with a conventional transformer, by HV LED or compact fluorescent lamps. The load type has an influence on the dimming principle to be used (leading edge phase control, trailing edge phase control, universal). The load type and the resulting dimming principle can be configured in the ETS.

If the load type is set to "universal", the dimmer actuator in this case must be recalibrated to the new load. To do this, the mains voltage of the load must first be switched off as well. It is always necessary to ensure that the load type configured in the ETS matches the connected load!



CAUTION!

Risk of destruction if the preset dimming principle and connected load do not match.

The dimmer and load may be destroyed.

Before changing the dimming principle, observe load type.

Before changing the load type, make sure that the dimming principle is correct.

Before changing the load type, disconnect the mains voltage of the device and the load circuit concerned. Check parameter settings and adjust if necessary.

- Disconnect the mains voltage of the load circuit.
In this case, depending on the ETS configuration, a load failure telegram can be transmitted to the bus if necessary (see "Load failure detection").
- Connect changed load.
- Put device into operation again (see page 16).
- ❗ Only with program version "1.2" and device generations "V02" and "V03":
When connecting dimmable HV-LED and compact fluorescent lamps, the load type that is suitable for this purpose (parameter setting: "LED...") must always be configured in the ETS.
- ❗ Only with program version "1.3" and device generations from "V04" and onwards:
When connecting dimmable and compact fluorescent lamps, the load type that is suitable for this purpose (parameter setting: "LED...") must always be configured in the ETS.
When connecting dimmable HV-LED or LV-LED lamps (with Tronic transformers or conv. transformers), you can choose between the universal dimming principle (as-delivered state) or, alternately, a suitable load type. Observe the lamp manufacturer's instructions.
- ❗ Operate dimmable HV-LED lamps or compact fluorescent lamps – depending on the specifications of the lamp manufacturer – preferably in the leading edge phase control. If the dimmer buzzes in this operating mode, check operation in the trailing edge phase control.
- ❗ In the function as speed controller (only with device variant "1-gang"), the load type and thus the dimming principle is predefined to unalterable in the ETS configuration (leading edge phase control operation).
- ❗ If the mains voltage supplies of the load outputs and the actuator are connected to various conductors, it is recommended to also install a multipolar circuit breaker for complete enabling.

Installing / removing the protective cap

To protect the bus lines against hazardous voltages in the area of the connecting terminals, a protective cap can be installed.

The cap is installed with the bus terminal in place and the connected bus line led out at the rear.

- To install the cap: slide the cap over the bus connecting terminal until you feel it engage (Figure 7).

- To remove the cap: Remove the cap by pressing the sides slightly and by pulling it out to the front (Figure 7).

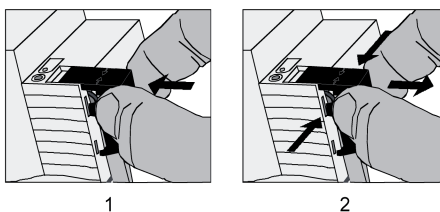

Figure 7: Installing / removing the protective cap for the bus connection

2.4 Commissioning

After installation of the device and connection of the bus line and mains voltage as well as electrical loads, the device can be put into operation. The following procedure is generally recommended...

Commissioning with the ETS

The device must be installed completely and connected to the mains voltage and loads.

- i** The device has a mains voltage connection that is independent of the load outputs for supplying the device electronics of the manual operation and integrated bus coupling unit. The device electronics and bus coupling unit are also supplied from the bus coupling unit so that an ETS programming operation or manual operation is also possible even if the mains voltage is not connected or is switched off. As long as the bus voltage is connected and ready for operation, the device's internal power supply is switched off to save energy.

The mains voltage is switched off completely.

Before programming the application program and parameters using the ETS, it must be ensured that the channel effect parameter configuration (parallel wiring) and the load type (dimming principle) correspond to the electric loads connected to the actuator.



DANGER!

Electrical shock when live parts are touched.

Electrical shocks can be fatal.

Before working on the device, disconnect the power supply and cover up live parts in the working environment.



CAUTION!

Risk of destruction if the preset dimming principle and connected load do not match.

The dimmer and load may be destroyed.

Before changing the dimming principle, observe load type.

Before changing the load type, make sure that the dimming principle is correct.

Before changing the load type, disconnect the mains voltage of the device and the load circuit concerned. Check parameter settings and adjust if necessary.

- Switch on the bus voltage Make sure that the bus voltage is available interruption free during the commissioning.
Check: When the programming button is pressed, the red programming LED must light up.
 - Configure and program the physical address with the help of the ETS.
 - Download the application data with the ETS.
 - Switch on mains voltage supplies of the load circuits.
The device calibrates itself to the loads and selects the appropriate dimming procedure if the load type is set to "universal" in the ETS. The dimming procedure can also be predefined with the parameterization. In this case, the calibration procedure is not necessary.
Afterwards, the actuator sets the brightness on the outputs that is predefined in the ETS in the "Behaviour after bus or mains voltage return" parameter. During the calibration phase, operations received are performed after finishing the calibration procedure.
 - Switch on mains voltage supply of the dimmer actuator (terminal pair "L N").
The device is ready for operation.
- i** The calibration procedure becomes noticeable during ohmic loads by a brief flicker and lasts between 1 to 10 seconds depending on the network conditions.

- i** The mains voltages of the load circuits and the mains voltage supply of the actuator are switched on simultaneously if, for example, all connections are clamped on the same outer conductor via a circuit breaker. If the load outputs and mains voltage of the dimmer actuator are supplied by different outer conductors or several circuit breakers, the load circuits should always be switched on before the mains voltage supply of the dimmer actuator. This ensures correct calibration of the actuator even for long conducting paths to the load.
- i** If a short-circuit is detected on a load output during the commissioning, the actuator cannot calibrate to the load. In this case, the fault must first be eliminated and the short-circuit reset (see page 24-25).
- i** When the mains supply is on, the outputs of the actuator can be switched manually even if there is no bus voltage or if the actuator is not yet programmed. Due to this feature, the loads connected to the individual outputs can be checked for proper functioning already during site operation.

Setting minimum speed (only for "1-gang" device variant in the "speed controller" operating mode)

When deployed as a speed controller, the device must be adapted to the minimum speed of the connected motor.

The ETS commissioning was performed successfully beforehand (see page 16-17).

The device is configured as a "speed controller".



CAUTION!

Connected motors must not stop.

Risk of destruction for motor and controlling device.

Set the minimum speed in such a way that the motor does not stop at a minimum setting.

- i** The speed of a connected motor (e.g. minimum speed) is configured in the ETS as a percentage value. This value represents the dimming value in percent and is a gauge for the output signal's phase angle of the actuator (phase cut-on operation).
 - Load the connected motor with the maximum load that occurs during operation.
 - Switch on device by manual or bus control.
The device switches on the connected motor to the cutting-in speed.
After the set resting time has elapsed, the device sets the currently required speed.
- i** In the presetting of the device, the cutting-in speed corresponds to the maximum speed of 100 %.
 - Slowly reduce the speed setting by means of a dimming procedure, e.g. by manual operation locally on the actuator, until the motor has reached its minimum permitted speed. While doing so, take the motor follow-up into account.
 - Ascertain the current speed by determining the current dimmer setting. This can be done, e.g., by selecting the current value of the communication object "Speed feedback" with the help of the ETS.
- i** The data format of the speed feedback is 1 byte. The actuator transmits dimensionless decimal values 0...255 via this object, which correspond to the percentage value range of 0...100 % and thus the dimming range of the actuator. Any selected value between 0...255 can be easily converted to the percentage value...
"Selected value" divided by "255" multiplied by "100 %"
 - Enter the determined value (in percent) as minimum speed in the parameter settings. Round up the value to the predefined values available in the ETS. The decimal values equivalent to the percentage values are displayed in the ETS as a configuration aid.

- Download the application data with the ETS.

2.5 Operation

2.5.1 Manual operation on device

Function

All load outputs of the device have electronic manual operation. The button field with 4 function keys and 3 status LEDs on the front panel of the device can be used for setting the following modes of operation...

- Bus control: operation from touch sensors or other bus devices.
- Temporary manual control: manual control locally with keypad, automatic return to bus control.
- Permanent manual control: local manual control with keypad.

- i** The operating modes can also be disabled by parameter settings in the ETS.
- i** When manual control is active, the outputs cannot be controlled via the bus.
- i** Manual control is possible only while the actuator is supplied with power from the mains or bus. In the event of bus and mains voltage failure, manual operation is terminated.
- i** The manual operation mode always ends in the event of bus voltage return.
- i** In manual mode, bus operation can be disabled via a telegram. Manual control is terminated on activation of the disabling function.
- i** Further details concerning manual control, especially with respect to the possible parameter settings and the interaction with other functions of the dimmer actuator can be found in chapter 4, "Software description" of the present documentation.

Controls and indicators for manual control

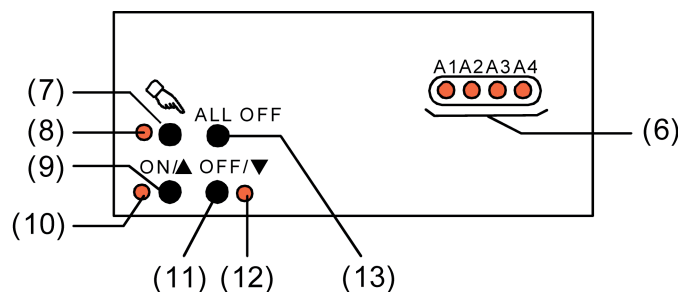



Figure 8: Controls and indicators for manual control
(using the example of the 4gang display variant)

- (6) Status LEDs
Indicate the state of the individual outputs. An LED lights up when an output is switched on (brightness: 1...100 %). One of the LEDs flashes when the corresponding output has been selected in manual operation by the button.
- (7) Button 
Activation / deactivation of manual control.
- (8) LED 
LED ON indicates permanent manual control.
- (9) Button ON/ ▲
Brief press: Output ON / Sustained press: Increase output brightness.
- (10) Status LED ON/ ▲
LED ON in manual control indicates a switched-on output (Brightness: 1...100 %).

- (11) Button OFF/▼
Brief press: Output OFF / Sustained press: Reduce output brightness.
- (12) Status LED OFF/ ▼
LED ON in manual control indicates a switched-off output (Brightness: 0 %).
- (13) Button ALL OFF
When pressing, all outputs are switched off (only in permanent manual operation).

Priorities for manual control

The device distinguishes between different functions that can have an effect on an output channel. In order to prevent conflicting output states, each available function has a certain priority. The function with the higher priority overrides the one with the lower priority...

- 1st priority: manual control (highest priority)
- 2nd priority: forced position or disabling function
- 3rd priority: direct operation via the bus ("switching" & "dimming" & "brightness" objects, scenes, central function)

Features of the device variant 4gang



To increase the channel power, the device variant "4-gang" can be wired in parallel by reducing the number of channel outputs. The assignment of parallel to wired dimming outputs to the KNX-controllable dimming channels takes place in the ETS.

With a parallel wiring, it is possible in 3-channel operation, for example, to assign the load outputs A1 and A2 to the KNX dimming channel 1. These outputs are then wired in parallel. In this example, the outputs A3 and A4 are then assigned to the dimming channels 2 and 3 and work independently.

The parallel wiring of the outputs has influence on the manual operation. In the example mentioned, the outputs A1 and A2 can only be used simultaneously in manual operation because they are assigned to the same KNX dimming channel. The Status LEDs on the front panel of the device subsequently flash at the same time during manual operation and always indicate the same switching state. This should be taken into account as a special case with device variant "4-gang".

Switching on the temporary manual control

Manual control is enabled in the ETS.

- Press  button briefly (< 1 s).
The status LED for output 1 flashes (LED  remains off).
-  After 5 s without a key-press, the actuator returns automatically to bus operation.

Deactivating temporary manual control



Temporary manual control was activated.

- No key-press for 5 s
- or -
- Select all outputs one after another by a brief press of the  button. Thereafter, press the key once again.
- or -

- induce bus reset (bus voltage return). Temporary manual control is terminated. The status LEDs A1...A4 indicate the status according to bus operation.
- i** The brightness value set via manual control is not changed when temporary manual control is switched off. If, however, a forced position or disabling function has been activated via the bus before or during manual operation, the actuator executes the disabling or forced reactions for the output channels concerned.

Switching on permanent manual control

Manual control is enabled in the ETS. Bus operation or temporary manual control is active.

- Press the  button for at least 5 s.
The status LED  is illuminated. The status LED for output 1 flashes. Permanent manual control is active:

Deactivating permanent manual control

Permanent manual control is active.

- Press the  key for at least 5 s.

- or -

- induce bus reset (bus voltage return). The status LED  goes out. The status LEDs A1...A4 indicate the status according to bus operation.
- i** Depending on the parameterization of the actuator in the ETS, the last predefined brightness values (direct operation, forced position / disabling function) of the outputs will be tracked or there is no reaction when the manual mode is shut off.

Controlling an output manually

Manual control (permanent or temporary) is activated.

- Select the desired output: Press the  key briefly (if necessary, repeatedly).
The status LED of the selected output A1...A4 flashes. The status LEDs "ON/ ▲" (1...100 %) or "OFF/ ▼" (0 %) indicate the brightness status of the output in the key pad.
- Operate the output by pressing the "ON/ ▲" button or "OFF/ ▼" button.
Short: switch on/off.
Long: dim brighter/darker.
Long and release: Stop dimming.

The selected output executes the corresponding commands immediately.

- i** An output cannot be switched on or dimmed if there is a load failure or short-circuit or if the dimmer actuator.

Switching off all outputs

Permanent manual control is active:

- Press "ALL OFF" button.
All outputs are shut off immediately (Brightness: 0 %). The outputs are not locked. Individual activation is again possible after shutoff.

- i** The "ALL-OFF" function is not available in temporary manual control.

Disabling bus control of individual outputs manually

Permanent manual control is active:

Disabling of the bus control mode must have been enabled in the ETS.

- Select the output: Press the  key briefly (if necessary, repeatedly).
The status LED of the selected output A1...A4 flashes. The status LEDs "ON/ ▲" (1...100 %) or "OFF/ ▼" (0 %) indicate the brightness status of the output in the key pad.
- Press the "ON/ ▲" and "OFF/ ▼" buttons simultaneously for at least 5 s.
The concerned output is disabled (no bus operation is possible). The status LED of the selected output A1...A4 flashes quickly.

- i** To unlock, proceed in the same way.
- i** An output that has been disabled in manual control can thereafter only be operated in permanent manual control.
- i** When a disabled output is selected in manual mode, the corresponding status LED flashes twice briefly with a time interval.

2.5.2 Behaviour in the event of problems with the load

Load failure detection

The universal dimmer actuator with a lighting control can monitor the electric circuits of its load outputs independent of each other. The actuator detects the mains voltage supply failures (> 15 s) of an output or the interruption of the electric circuit when a load is switched on or off. The load failure detection in case of use must be enabled separately in the ETS for a dimming channel (cf. chapter 4 "Software description").

- i** No message of a load failure is possible with the device variant "speed controller" operating mode in the "1-gang" and device variant "4-gang" and "parallel wired outputs" (only in application program version "1.1"). No load failure message can be configured in the ETS in this case.

A load failure due to an interruption of the load circuit, – e.g. for checking a lamp – can only be reliably detected when a load that interrupts the circuit completely in the case of a fault is connected to an output. Therefore, a failed lamp can only be clearly detected if ...

- just one incandescent light bulb is connected and is faulty (e.g. broken filament),
- just one high-voltage halogen lamp is connected and is faulty.

Other loads or mixed loads do not normally permit the detection of a failed lamp. It is only possible to detect a faulty lamp if ...

- halogen lamps are connected via conventional or electronic transformers,
- an incandescent lamp is connected as mixed load to a conventional or electronic transformer,
- several incandescent lamps or HV halogen lamps are connected in parallel.

- i** If the load failure detection is enabled in the ETS, a message telegram "Load failure detected – 1" is transmitted from the actuator to the bus approx. 15 ...20 seconds after identification of the load failure.
- i** A mains voltage failure of the output is always detected as load failure if the mains voltage failure lasts longer than approx. 15 seconds.
- i** A faulty fuse in the primary circuit of a conventional transformer normally results in a load failure not being detected.
- i** In the event of a load failure, the actuator sets the switching status of the dimming channel concerned to "OFF" and the status of the brightness value to "0" and transmits these values to the bus if enabled in the ETS.
- i** The actuator initialises the objects "Signal load failure / overload" of all dimming channels after an ETS programming operation and after switching on the bus voltage or the mains power supply according to the current status. In this case, it should be noted that the "Delay after bus voltage return" configured in the ETS must have elapsed before load failure message telegrams are transmitted to the bus.

Eliminate load failure

The dimmer actuator has detected a load failure on an output.

- Disconnect the mains voltage of the load circuit concerned.
- Ascertain the cause of the load failure and eliminate.
- Switch on mains voltage again of the load circuit.

The load failure is reset. After resetting the load failure, the dimming channel concerned is switched off and can subsequently be switched on or dimmed again as usual.

- i** After eliminating the load failure and switching on the mains voltage again in the load circuit, the load is recalibrated if the load type is set to "universal" in the ETS. The calibration procedure becomes noticeable during ohmic loads by briefly flickering twice and lasts up to 10 seconds depending on the network conditions.
- i** At least 15 seconds after switching on the mains voltage, the actuator transmits a message telegram "no load failure – 0" to the bus if the load failure was eliminated. Otherwise, a load failure message is transmitted again. No message telegram is transmitted within the "Delay after bus voltage return".

Mains interruption

The device detects mains interruptions at the load connections, as they are caused by faults in the public low-voltage power supply, for example. If a detected mains interruption on an output only lasts for up to approx. 2 seconds, the dimmer actuator activates the old brightness value for the outputs concerned after mains return and shows no further reaction.

If the mains interruption lasts for more than approx. 2 seconds, the dimmer actuator generates a reset for the outputs concerned after mains voltage return. At the same time, the dimmer outputs concerned are reinitialized with the ETS configuration data. The load is also recalibrated if the load type is set to "universal" in the ETS. During the initialization after the mains voltage failure, the outputs affected by the mains failure are switched off. The actuator thereby also transmits switching status and value feedbacks to the bus, if configured in the ETS. Thereafter, the dimming channels can be switched on again as usual. If the mains failure lasts longer than 15 s, a load failure, if used, is also signalled to the bus (see "Load failure detection").

- i** In the case of a 'hard mains interruption', which is caused, for example, by disconnection via a circuit breaker, the detection time of the mains failure on the load connections can last for up to 7 seconds (instead of 2 seconds) due to additional debounce delays.

In the case of a bus and mains voltage supply failure of the dimmer actuator (terminal pair "L N" next to the bus connection), the reset is always generated for all outputs after mains voltage return. At the same time, the dimmer outputs concerned are reinitialized with the ETS configuration data. The loads are also recalibrated if the load types are set to "universal" in the ETS. After the initialization, the outputs are set according to the ETS parameter "Behaviour after bus or mains voltage return".

After mains return, no reaction occurs provided that the bus voltage was available interruption free.

Short-circuit and over-temperature detection

Short-circuit protection and over-temperature protection are integrated in the device for each output.

If the device detects a short-circuit, the load is switched off automatically after 7 seconds in phase cut-off operation (capacitive and ohmic loads) or after 100 milliseconds in phase cut-on operation (inductive loads). After switching off, the actuator transmits a message telegram "Short-circuit present – 1" to the bus for the dimming channel concerned, if this message is enabled in the ETS. A short-circuit must be reset (see page 25-26).

If there is an over-temperature in the device, the load is switched off by the temperature control of the device. The actuator, 15 seconds after switching off, transmits a message telegram "Load failure present – 1" to the bus for the dimming channel concerned if this message is enabled in the ETS. In this state, the dimming channel concerned can no longer be switched on by manual or bus control. To reset such a fault, it might be necessary to switch off the mains voltage supply of the load outputs. Over-temperatures in the device either occur as a result of self-heating (electrical overload) or external influences (ambient temperature in the control cabinet is too high).

- i** If an over-temperature switch-off occurs, the installation situation of the device must be checked. If the over-temperature occurs regularly, measures must be taken (e. g. provide cooling, increase distance to surrounding devices, reduce connected load).

- i** If the over-temperature protection is activated again shortly after resetting, the device's self-protection takes effect permanently (the device is then apparently faulty). As a result, the device must be replaced.
- i** With the device variants "2-gang" and "4-gang", the reaction of the dimming outputs depends on the load situation after an overload-temperature switch-off. The load defines a holding current during an over-temperature switch-off. A dimmer output remains switched off permanently after the over-temperature switch-off if the holding current exceeds a defined threshold. In this case, the over-temperature switch-off must be reset "manually" (see page 26-27). If the holding current does not exceed the threshold, the dimmer output switches on again automatically after cooling down. At the same time, the outputs concerned pass through a reset whereby they are reinitialized with the ETS configuration data. As a result, the load is also recalibrated if the load type is set to "universal" in the ETS. Thereafter, the dimming outputs execute the reaction after mains voltage return.
- i** With the device variant "1-gang", the dimmer output remains switched off permanently after an over-temperature switch-off. In this case, the over-temperature switch-off must always be reset "manually" (see page 26-27). In the case of a device's self-protection that takes effect continuously, it should be noted that a manual reset of the over-temperature switch-off is not possible. The device must then be replaced.

The device is also protected against electrical overload. Electrical overloads occur when the nominal operation parameters of a dimmer output are exceeded temporarily or continuously. The reaction of a device then depends on how great the electrical overload is and which ambient conditions prevail. If the overload exceeds the defined short-circuit threshold, the device switches off the dimming channel concerned after 7 seconds at the latest, depending on the load type. In this case, the actuator generates a short-circuit message on the bus if this feedback is enabled in the ETS.

If the electrical overload does not exceed the short-circuit threshold, the device does not heat up continuously. Whether and how rapidly this self-heating occurs depends essentially on how great the overload is and how much the device is thermally influenced from outside. The heating up of the device causes the over-temperature switch-off to take effect from a certain temperature threshold. In this case, the actuator generates a load failure message on the bus if this feedback is enabled in the ETS.

Consequently, the device protects itself constantly by means of short-circuit or over-temperature switch-off even in the case of an electrical overload.

- i** Special case "Parallel wired outputs" with the device variant "4-gang".
An over-temperature switch-off is performed selectively for each output, i.e. each load output has its own protection against thermal overload. During a thermal overload, only a few outputs of the dimming channel concerned may switch off because of different temperature conditions in the device.

Reset short-circuit

If the device has detected a short-circuit on an output, this fault must then be eliminated and the output reset before the dimming channel concerned can be switched on again.

The device has detected a short-circuit for an output.

- Disconnect the mains voltage of the load circuit concerned.
- Switch off mains voltage supply of the device (terminal pair "L N" next to the bus connection).
- Ascertain the cause of the short-circuit and eliminate.
- Switch on mains voltage again of the load circuit.
- Switch on the mains supply of the device again.

The short-circuit is reset. The dimming channel can subsequently be switched on or dimmed again as usual.

- i After eliminating the short-circuit and switching on the mains voltage, the load is recalibrated if the load type is set to "universal" in the ETS. The calibration procedure becomes noticeable during ohmic loads by briefly flickering twice and lasts up to 10 seconds depending on the network conditions.
- i After switching on the mains voltage, the actuator transmits a message telegram "no short-circuit – 0" to the bus if the short-circuit was eliminated. Otherwise, a short-circuit message is transmitted again.
- i If the output of a dimming channel was switched off due to a short-circuit, the actuator also transmits switching status and value feedbacks (lighting "OFF") to the bus, if configured in the ETS.
- i In the event of a short-circuit, the actuator handles parallel wired outputs of the device variant "4-gang" identically because the short-circuit occurs at the same time for all load outputs assigned to the dimming channel. The short-circuit is then reported to the bus via the dimming channel concerned.
- i The reset of a short-circuit detection and thus the message that was transmitted to the bus can also be performed by switching off the dimming channel concerned. It is possible to switch off via...
 - the "switching" object with the switching command "OFF",
 - the "brightness value" object with the value "0",
 - a scene recall with the brightness value "0",
 - a manual operation with the command "OFF".

A bus voltage failure with subsequent bus voltage return also triggers a short-circuit reset. The reset of a short-circuit message simply by switching off can be helpful when determining whether the short-circuit situation is still present. If switching on the dimming channel concerned results in a short-circuit message again, there is still a fault in the system.

To eliminate a short-circuit, for safety reasons, the mains voltage supply of the load and dimmer actuator must always be disconnected as described in the operational procedure!
- i The actuator initialises the objects "Signal short-circuit" of all dimming channels after an ETS programming operation and after switching on the bus voltage according to their current status. In this case, it should be noted that the "Delay after bus voltage return" configured in the ETS must have elapsed before short-circuit message telegrams are transmitted to the bus.

Resetting permanent over-temperature switch off

The device has switched off one or more load outputs permanently because over-temperature was detected.

- Switch off the mains voltage supply of the device (terminal pair "L N") and the mains voltage supply of all load outputs.
- Let the device cool down for at least 15 minutes.
- Switch on the mains voltage supply again of the device and mains voltage supply of all load outputs.

At the same time, the dimmer outputs concerned are reinitialized with the ETS configuration data. The load is also recalibrated if the load type is set to "universal" in the ETS.

- For testing purposes, switch on the dimming channel, which was affected previously due to the over-temperature switch-off, by manual or bus operation.

The connected load switches on.

- i If a dimming channel was switched off due to an over-temperature, the actuator also transmits switching status and value feedbacks (lighting "OFF") and a load failure message (delayed by 15 seconds) to the bus, if configured in the ETS.
- i After switching on the mains voltage supply, the actuator transmits a message telegram "no load failure – 0" to the bus if the source of the over-temperature was reliably eliminated. Otherwise, the over-temperature may reoccur after a certain period of operation.

- i** If an over-temperature switch-off occurs, the installation situation of the device must be checked. If the over-temperature occurs regularly, measures must be taken (e.g. provide cooling, increase distance to surrounding devices, reduce connected load).
- i** If the over-temperature protection is reactivated shortly after resetting, the device's self-protection takes effect permanently (the device is then apparently faulty). As a result, the device must be replaced.
- i** Special case "Parallel wired outputs" with the device variant "4-gang".
An over-temperature switch-off is performed selectively for each output, i.e. each load output has its own protection against thermal overload. During a thermal overload, just a few outputs of the dimming channel concerned may switch off at first because of different temperature conditions in the device.

Overvoltage detection

The device can detect overvoltage on a dimming output. Overvoltage occurs, for example, if the dimming principle "Phase cut-off" set in the parameters for LED lamps does not match the load. If overvoltage is detected, the device switches off the dimming output affected. This protects the device against destruction. If overvoltage is detected, the load is switched off automatically after 7 seconds in phase cut-off operation and after 100 milliseconds in phase cut-on operation.

After switching off, the actuator transmits a message telegram "Short-circuit/Overload present – 1" - as in the case of a detected short-circuit or overload - to the bus for the dimming channel concerned, if this message is enabled in the ETS. The resetting of a switched-off output due to overvoltage is possible in the same way as the resetting of a short-circuit message (see page 25-26).

3 Technical data

General

Test mark	KNX/EIB
Ambient temperature	-5 ... +45 °C
Storage/transport temperature	-25 ... +70 °C
Housing temperature	75 °C (tc)
Installation position	as desired (preferably top output terminals)
Fitting width	
Order No. 36371-1.REG	72 mm / 4 modules
Order No. 36372-2.REG	72 mm / 4 modules
Order No. 36374-4.REG	144 mm / 8 modules

Terminals for mains supply and outputs

Connection mode	Screw terminal
single stranded	0.5 ... 4 mm ²
Finely stranded without conductor sleeve	0.5 ... 4 mm ²
Finely stranded with conductor sleeve	0.5 ... 2.5 mm ²
Connection torque	max. 0.8 Nm

KNX supply

KNX medium	TP
Commissioning mode	S-mode
Rated voltage KNX	DC 21 ... 32 V SELV
Current consumption KNX	15 mA
Connection mode KNX	device connection terminal

External supply

Rated voltage	AC 110 ... 230 V ~
Mains frequency	50 / 60 Hz
Power loss	
Order No. 36371-1.REG	max. 4 W
Order No. 36372-2.REG	max. 4 W
Order No. 36374-4.REG	max. 8 W
Standby power	
Order No. 36371-1.REG	max. 0.5 W
Order No. 36372-2.REG	max. 0.8 W
Order No. 36374-4.REG	max. 1.4 W

Outputs

Contact type	ε, MOSFET
Switching voltage	AC 230 V ~
Switching current motors	
Order No. 36371-1.REG	2.3 A
Order No. 36372-2.REG	—
Order No. 36374-4.REG	—
Cable length	max. 100 m

Connected load 230 V AC

Incandescent lamps	
Order No. 36371-1.REG	20 ... 500 W
Order No. 36372-2.REG	20 ... 300 W
Order No. 36374-4.REG	20 ... 250 W
HV halogen lamps	
Order No. 36371-1.REG	20 ... 500 W
Order No. 36372-2.REG	20 ... 300 W
Order No. 36374-4.REG	20 ... 250 W

Inductive transformers	
Order No. 36371-1.REG	20 ... 500 VA
Order No. 36372-2.REG	20 ... 300 VA
Order No. 36374-4.REG	20 ... 250 VA
Tronic transformers	
Order No. 36371-1.REG	20 ... 500 W
Order No. 36372-2.REG	20 ... 300 W
Order No. 36374-4.REG	20 ... 250 W
HV-LED lamps	
Order No. 36371-1.REG	typ. 3 ... 100 W
Order No. 36372-2.REG	typical 3 ... 60 W
Order No. 36374-4.REG	typical 3 ... 50 W
Compact fl lamp.	
Order No. 36371-1.REG	typ. 3 ... 100 W
Order No. 36372-2.REG	typical 3 ... 60 W
Order No. 36374-4.REG	typical 3 ... 50 W

Only with program versions "1.3" in combination with device generations from "V04" and onwards:

Mixed load 230 V AC		
ohmic-inductive		
Order No. 36371-1.REG	20 ... 500 VA	
Order No. 36372-2.REG	20 ... 300 VA	
Order No. 36374-4.REG	20 ... 250 VA	
ohmic-capacitive		
Order No. 36371-1.REG	20 ... 500 W	
Order No. 36372-2.REG	20 ... 300 W	
Order No. 36374-4.REG	20 ... 250 W	
capacitive-inductive		not permitted

Connected load 110 V AC	
Incandescent lamps	
Order No. 36371-1.REG	20 ... 250 W
Order No. 36372-2.REG	20 ... 150 W
Order No. 36374-4.REG	20 ... 120 W
HV halogen lamps	
Order No. 36371-1.REG	20 ... 250 W
Order No. 36372-2.REG	20 ... 150 W
Order No. 36374-4.REG	20 ... 120 W
Inductive transformers	
Order No. 36371-1.REG	20 ... 250 VA
Order No. 36372-2.REG	20 ... 150 VA
Order No. 36374-4.REG	20 ... 120 VA
Tronic transformers	
Order No. 36371-1.REG	20 ... 250 W
Order No. 36372-2.REG	20 ... 150 W
Order No. 36374-4.REG	20 ... 120 W
HV-LED lamps	
Order No. 36371-1.REG	typical 3 ... 50 W
Order No. 36372-2.REG	typical 3 ... 30 W
Order No. 36374-4.REG	typical 3 ... 24 W
Compact fl lamp.	
Order No. 36371-1.REG	typical 3 ... 50 W
Order No. 36372-2.REG	typical 3 ... 30 W
Order No. 36374-4.REG	typical 3 ... 24 W

Only with program versions "1.3" in combination with device generations from "V04" and onwards:

Mixed load 110 V AC

ohmic-inductive	
Order No. 36371-1.REG	20 ... 250 VA
Order No. 36372-2.REG	20 ... 150 VA
Order No. 36374-4.REG	20 ... 120 VA
ohmic-capacitive	
Order No. 36371-1.REG	20 ... 250 W
Order No. 36372-2.REG	20 ... 150 W
Order No. 36374-4.REG	20 ... 120 W
capacitive-inductive	not permitted

Total power consumption at 230 V

Order No. 36371-1.REG	—
Order No. 36372-2.REG	max. 600 W/VA
Order No. 36374-4.REG	—

- i** In the case of unbalanced load, an output of the device variant "2-gang" may be loaded with a max of 350 W/VA (230 V) as long as the permissible total power consumption is not exceeded.

Total power consumption at 110 V

Order No. 36371-1.REG	—
Order No. 36372-2.REG	max. 300 W/VA
Order No. 36374-4.REG	—

- i** In the case of unbalanced load, an output of the device variant "2-gang" may be loaded with a max of 175 W/VA (110 V) as long as the permissible total power consumption is not exceeded.



The icons used to label the dimmer load shows the load type that can be connected to a dimmer and the electric behaviour of a load:

R = ohmic, L = inductive, C = capacitive, M = motors,
HV-LED = dimmable HV-LED lamps

- i** HV-LED and compact fluorescent lamps generate high pulsed currents, when they are operated in the leading edge phase control. Depending on the design and power rating of these lamps, the actual connected load of the specified values (label, housing or packaging) could vary. The actual connected load of the aforementioned lamps is often higher than the power rating specified. As a result, load outputs of the dimmer actuator are loaded more greatly than power rating.
The connectable power for dimmable HV LEDs and compact fluorescent lamps are specified in this documentation as "typical" since the specified nominal values of the lamps (depending on manufacturer and type) cannot be compared with the connected load or only with difficulty. The actual connected load of the lamps used must not exceed the connected load specified in this documentation!

4 Software description

4.1 Software specification

ETS search paths:	Lighting / Dimmer 1fold / Dimming actuator 1fold, REG Lighting / Dimmer 2fold / Dimming actuator 2fold, REG Lighting / Dimmer 4fold / Dimming actuator 4fold, REG
Configuration:	S-mode standard
PEI type:	"00" _{Hex} / "0" _{Dec}
PEI connector:	no connector

Application programs for 1-gang device variant

No.	Short description	Name	Version	from mask version
1	Multifunctional control of 1 dimmer output for lighting control incl. control of HV LED and compact fluorescent lamps. Alternative function as speed controller for controlling the speed of single-phase electric motors.	Dimming actuator / 1-gang / 230V / 16A V2.0	1.2 for ETS 3.0 version d and onwards , ETS4 and ETS5	705
2	Multifunctional control of 1 dimmer output for lighting control incl. control of HV LED, LV LED and compact fluorescent lamps. Alternative function as speed controller for controlling the speed of single-phase electric motors.	Dimming actuator / 1-gang / 230V / 16A V3.0	1.3 for ETS 3.0 version d and onwards , ETS4 and ETS5	705

Application programs for 2-gang device variant

No.	Short description	Name	Version	from mask version
1	Multifunctional control of 2 dimmer outputs for lighting control incl. control of HV LED and compact fluorescent lamps.	Dimming actuator / 2-gang / 230V / 16A V2.0	1.2 for ETS 3.0 version d and onwards , ETS4 and ETS5	705

2	Multifunctional control of 2 dimmer outputs for lighting control incl. control of HV LED, LV LED and compact fluorescent lamps.	Dimming actuator / 2-gang / 230V / 16A V3.0	1.3 for ETS 3.0 version d and onwards , ETS4 and ETS5	705
---	---	---	---	-----

Application programs for 4-gang device variant

No.	Short description	Name	Version	from mask version
1	Multifunctional control of up to 4 dimmer outputs for lighting control incl. control of HV LED and compact fluorescent lamps.	Dimming actuator / 4-gang / 230V / 16A V2.0	1.2 for ETS 3.0 version d and onwards , ETS4 and ETS5	705
2	Multifunctional control of up to 4 dimmer outputs for lighting control incl. control of HV LED, LV LED and compact fluorescent lamps.	Dimming actuator / 4-gang / 230V / 16A V3.0	1.3 for ETS 3.0 version d and onwards , ETS4 and ETS5	705

4.2 Software "Dimming actuator"

4.2.1 Scope of functions

General:

- There are up to 4 dimming channels available depending on the device variants.
- To simplify the configuration, all existing dimming channels can be assigned to the same parameters in the ETS and thus configured identically.
- For "4-gang" device variant: To increase the channel power, outputs can be wired in parallel by reducing the number of channels (not with HV-LED, LV-LED lamps or compact fluorescent lamps). The assignment of parallel to wired dimming outputs to the KNX-controllable dimming channels takes place in the ETS.
- For device variant "1-gang": Apart from controlling lighting, the actuator 1-gang can be used as a speed controller of single-phase electric motors.
- Manual operation of the outputs independently of the bus (also building site operation possible).
- Central switching function for collective control of all dimming channels.
- Delay for actively transmitting feedbacks after bus voltage return.

Channel-oriented:

- Independent control of up to 4 dimmer outputs. Each dimming channel offers the full scope of functions without any restrictions. All channel-oriented functions can be parameterized separately for each dimming channel. This feature permits independent and multi-functional control.
- It is possible to specify the load type and thus define the dimming principle.
- Feedback "switching" and "brightness value" configurable. One active (object transmitting) or passive (object readable) feedback function each is configurable. In the case of an actively transmitting object, the feedback values can be optionally cyclical and transmitted with a delay after a device reset.
The actuator updates the feedback values only after a change or after each update of the corresponding input objects.
- Setting of the dimmable brightness range is possible ("basic brightness and maximum brightness" or "minimum brightness and maximum brightness").
- Automatic setting and scaling of the dimmable brightness range when using Universal power boosters.
- Dimming behaviour (also fading) and dimming characteristics configurable.
- Soft switch-on and soft switch-off function.
- The response of a dimming channel in the state "OFF" when receiving a relative dimming command can be configured (switch on and dim up or no reaction).
- In the case of a short-circuit and load failure or overload, message telegrams can be transmitted to the bus (load failure/overload message not with "1-gang" device variant in the speed controller" operating mode"). Feedback of the connected load type is also possible.
- Disabling function, or alternatively, forced position function is configurable for each output. During a disabling function, the flashing of connected luminaires is not possible.
- Timing functions (switch-on delay, switch-off delay, staircase lighting timer) With the staircase lighting timer the reaction at the end of the switch-on time can be configured (pre-warning function by means of time-controlled reduction of the lighting or activation of the permanent lighting, e.g. for hallways).
- Logic operation function possible (not with enabled staircase function). In the logic operation function the switching value of an additional object can be linked logically to the "switching" object and the result of the logic operation transmitted to the dimming channel output.
- A dimming channel can be integrated in up to 8 light-scenes.
- The switch-on times can be detected and evaluated by operating hours counters.
- Behaviour in case of bus voltage failure and bus voltage return as well as after ETS programming presettable.

4.2.2 Notes on software

ETS project design and commissioning

For project design and commissioning of the device, ETS3.0 from Version "d" onwards, ETS4 or ETS5 is required. Through use of these ETS version or later versions, advantages are gained with regard to the programming process.

Device generations and using the application programs

There are different application programs available. The use of application programs with the new version together with a specially designated device generation results in functional differences as compared with the combination of older applications and devices. It is possible to distinguish between the application programs and device generations by means of the version designation (see the following table)...

Device variant	Application program	Version:	Use for devices with label
1-gang	Dimming actuator / 1-gang / 230V / 16A V3.0	1.3	from "V04"
2-gang	Dimming actuator / 2-gang / 230V / 16A V3.0	1.3	from "V04"
4-gang	Dimming actuator / 4-gang / 230V / 16A V3.0	1.3	from "V04"
1-gang	Dimming actuator / 1-gang / 230V / 16A V2.0	1.2	"V02", "V03"
2-gang	Dimming actuator / 2-gang / 230V / 16A V2.0	1.2	"V02", "V03"
4-gang	Dimming actuator / 4-gang / 230V / 16A V2.0	1.2	"V02", "V03"

Application programs and device generations

The designation of the device generation is attached on the device label. Depending on the device variant (1-gang, 2-gang or 4-gang) the designation is in different positions (Figure 9).

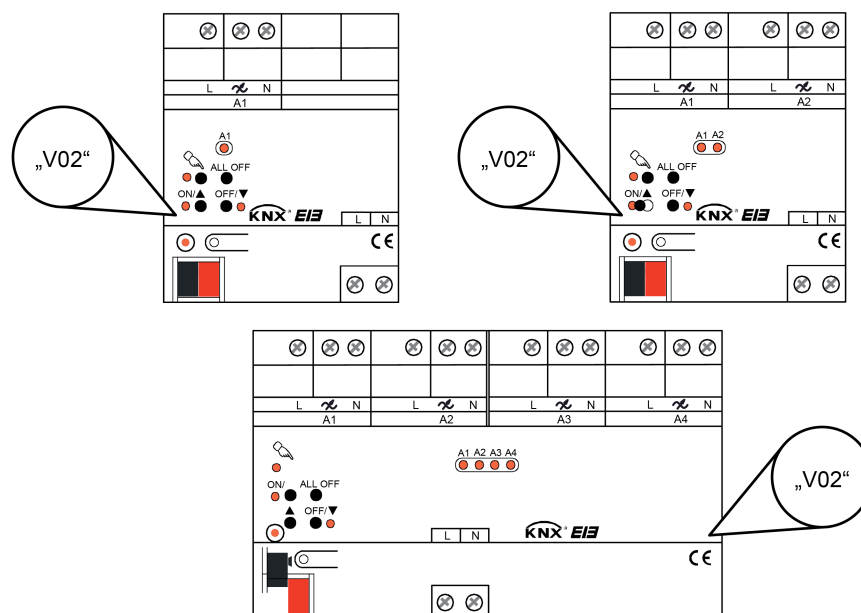

Figure 9: Position of the designation of the device generation

This product documentation describes the scope of functions of all application programs and device generations and will deal with the functional differences at the appropriate places if necessary.

With combinations of "V3.0" of the application program with the device generations of "V04" or higher, this produces the following extended functions...

- Activation of LV-LEDs (via Tronic transformers or conventional transformers),
- Automatic calibration using the universal dimming principle for HV and LV-LED lamps possible.

Only by combining the old application programs ("V2.0") with the new device generations (from "V04") is the scope of functions of the old application supported (see following table). The programming of more recent application versions (e.g. "V3.0") in old devices (up to and including "V03") only allows execution of the scope of functions of old device generations.

G	A	Load type LED / CFL
V02, V03	V2.0	HV-LED, CFL
V02, V03	V3.0	HV-LED, CFL
from V04	V2.0	HV-LED, CFL
from V04	V3.0	HV-LED, LV-LED, CFL

Available functions depending on device generation and application version

D = Device generation

A = Application version

CFL = Compact fluorescent lamps

Safe-state mode

If the device does not work properly - for instance as a result of errors in the project design or during commissioning - the execution of the loaded application program can be halted by activating the safe-state mode. The safe-state mode does not permit controlling the outputs via the bus and by hand. The actuator remains passive since the application program is not being executed (state-of-execution: terminated). Only the system software is still functional so that the ETS diagnosis functions and also programming of the device continue to be possible.

Activating the safe-state mode

- Shut off the bus and the mains voltage supply.
- Press and hold down the programming button.
- Switch on the bus or mains voltage. Release the programming button only after the programming LED starts flashing slowly.

The safe-state mode is activated. With a new brief press of the programming button, the programming mode can be switched on and off as usual also in the safe-state mode. The programming LED will nevertheless continue to flash independently of the programming mode as long as the safe-state mode is active.

- i** The safe-state mode can be terminated by switching off the supply voltage (bus and mains) or by programming with the ETS.

Unloading the application program

The application program can be unloaded with the ETS. In this case, manual control as part of the application program is not available either.

4.2.3 Object table

Number of communication objects:	75 (max. object number 74 - gaps in between)
Number of addresses (max):	254
Number of assignments (max):	255
Dynamic table management	no
Maximum table length	255

Channel-independent objects

Function: Manual operation

Object	Function	Name	Type	DPT	Flag
 ⁰	Disabling	Manual operation	1-bit	1,003	C, W, -, (R) ¹

Description 1-bit object for disabling the buttons for manual control on the device. The polarity can be configured.

Function: Manual operation

Object	Function	Name	Type	DPT	Flag
 ¹	Status	Manual operation	1-bit	1,002	C, -, T, (R) ²

Description 1-bit object for manual control status transmission. The object is "0", when manual control is deactivated (bus control). The object is "1", when manual control is being activated. You can configure whether the temporary or the permanent manual control will be indicated as status information or not.

Function: Central function

Object	Function	Name	Type	DPT	Flag
 ²	Switching	Central	1-bit	1,001	C, W, -, (R) ¹

Description 1-bit object for central switching of assigned output channels. The polarity can be configured.

1: For reading, the R-flag must be set. The last value written to the object via the bus will be read.

2: For reading, the R-flag must be set. The last value written to the object by the device will be read out.

Channel-oriented objects**(for "lighting control" operating mode with the device variants "1-gang", "2-gang" and "4-gang")**

Function: Channel switching

Object	Function	Name	Type	DPT	Flag
 3, 21, 39, 57	Switching	Channel 1...4	1-bit	1,001	C, W, -, (R) ₁

Description 1-bit object for switching the dimming channel on or off ("1" = switch on; "0" = switch off).

Function: Relative dimming of channel

Object	Function	Name	Type	DPT	Flag
 6, 24, 42, 60	Dimming	Channel 1...4	4-bit	3,007	C, W, -, (R) ₁

Description 4-bit object for relative dimming of a dimming channel.

Function: Absolute dimming of channel

Object	Function	Name	Type	DPT	Flag
 7, 25, 43, 61	Brightness value	Channel 1...4	1 byte	1,003	C, W, -, (R) ₁

Description 1-byte object for predefining an absolute dimming value (brightness value 0...255) from the bus.

Function: Switching feedback

Object	Function	Name	Type	DPT	Flag
 8, 26, 44, 62	Switching feedback	Channel 1...4	1-bit	1,001	C, -, T, (R) ₂

Description 1-bit object for feedback signalling of the switching state ("1" = on / "0" = off) to the bus.

Function: Absolute dimming feedback

Object	Function	Name	Type	DPT	Flag
 9, 27, 45, 63	Feedback brightness value	Channel 1...4	1 byte	5,001	C, -, T, (R) ₂

Description 1-byte object for feedback signalling of a set dimming value (brightness value 0...255) to the bus.

1: For reading, the R-flag must be set. The last value written to the object via the bus will be read.

2: For reading, the R-flag must be set. The last value written to the object by the device will be read out.

Function:	Staircase function				
Object	Function	Name	Type	DPT	Flag
 4, 22, 40, 58	Staircase function start / stop	Channel 1...4	1-bit	1,010	C, W, -, (R) 1
Description	1-bit object to activate or deactivate the switch-on time of the staircase function of a dimming channel ("1" = switch-on / "0" = switch-off).				

Function:	Staircase function				
Object	Function	Name	Type	DPT	Flag
 5, 23, 41, 59	Staircase time factor	Channel 1...4	1 byte	5,010	C, W, -, (R) 1
Description	1-byte object to specify a time factor for the switch-on time of the staircase function (value range: 0 ... 255).				





Function:	Disabling function				
Object	Function	Name	Type	DPT	Flag
 10, 28, 46, 64	Disabling	Channel 1...4	1-bit	1,003	C, W, -, (R) 1
Description	1-bit object for disabling a dimming channel (polarity configurable).				

Function:	Forced position function				
Object	Function	Name	Type	DPT	Flag
 11, 29, 47, 65	Forced position	Channel 1...4	2-bit	2,001	C, W, -, (R) 1
Description	2-bit object for the forced position of a dimming channel. The polarity is fixed by the telegram.				

Function:	Scenes				
Object	Function	Name	Type	DPT	Flag
 12, 30, 48, 66	Scene extension	Channel 1...4	1 byte	18,001	C, W, -, (R) 1
Description	1-byte object for recalling scenes or for storing new scene values.				

Function:	Logic operation function				
Object	Function	Name	Type	DPT	Flag
 13, 31, 49, 67	Logic operation	Channel 1...4	1-bit	1,002	C, W, -, (R) 1
Description	1-bit object for the input of the logical link of a dimming channel. After bus voltage return or after programming with the ETS, the object value can be predefined for each parameter.				

1: For reading, the R-flag must be set. The last value written to the object via the bus will be read.

Function:		Short-circuit monitoring				
Object	Function	Name	Type	DPT	Flag	
 14, 32, 50, 68	Signalling short-circuit	Channel 1...4	1-bit	1,005	C, -, T, (R) 1	
Description		1-bit object for signalling short-circuit in relation to a dimming channel. ("1" =short-circuit present, "0" = short-circuit not present).				
Function:		Load failure / overload monitoring				
Object	Function	Name	Type	DPT	Flag	
 15, 33, 51, 69	Signalling load failure/overl.	Channel 1...4	1-bit	1,005	C, -, T, (R) 1	
Description		1-bit object for signalling a load failure or overload in relation to a dimming channel. ("1" = load failure/overload present / "0" = load failure/overload not present).				
Function:		Operating hours counter				
Object	Function	Name	Type	DPT	Flag	
 16, 34, 52, 70	Limit value / starting value operating hours counter ²	Channel 1...4	2 byte	7,007	C, W, -, (R) 3	
Description		2-byte object for external specification of a limit value / starting value of the operating hours counter of a dimming channel. Value range: 0... 65535				
Function:		Operating hours counter				
Object	Function	Name	Type	DPT	Flag	
 17, 35, 53, 71	Restart op. hours counter	Channel 1...4	1-bit	1,015	C, W, -, (R) 3	
Description		1-bit object for resetting the operating hours counter of a dimming channel ("1" = restart, "0" = no reaction).				
Function:		Operating hours counter				
Object	Function	Name	Type	DPT	Flag	
 18, 36, 54, 72	Value operating hours counter	Channel 1...4	2 byte	7,007	C, -, T, (R) 1	
Description		2-byte object to transmit or read out the current counter level of the operating hours counter. If the bus voltage should fail, the value of the communication object is not lost and is actively transmitted to the bus after bus voltage return or an ETS programming operation. In the as-delivered state, the value is "0".				
1: For reading, the R-flag must be set. The last value written to the object by the device will be read out.						
2: Threshold value object or start value object depending on the configured counter type of the operating hours counter.						
3: For reading, the R-flag must be set. The last value written to the object via the bus will be read.						

Object	Function	Name	Type	DPT	Flag
Function: Operating hours counter					
 19, 37, 55, 73	Operating hrs counter elapsed	Channel 1...4	1-bit	1,002	C, -, T, (R) 1
Description	1-bit object to sign that the operating hours counter has elapsed (forwards counter = limit value reached / backwards counter = value "0" reached). With a message, the object value is actively transmitted to the bus ("1" = message active / "0" = message inactive). If the bus voltage should fail, the value of the communication object is not lost and is actively transmitted to the bus after bus voltage return or an ETS programming operation.				

Object	Function	Name	Type	DPT	Flag
Function: Load type feedback					
 20, 38, 56, 74	Signalling load type	Channel 1...4	1 byte	20.xxx	C, -, T, (R) 1
Description	1-byte object for signalling the set load type of a dimming channel. "0" = undefined (no calibration possible because mains voltage absent / short-circuit) "1" = trailing edge phase control (set by parameter) "2" = leading edge phase control (set by parameter) "3" = universal, adjusted to capacitive or ohmic load "4" = universal, adjusted to inductive load "5 ...255" not used				

Channel-oriented objects (for the "speed controller" operating mode only for "1-gang" device variant)

Object	Function	Name	Type	DPT	Flag
Function: Channel switching					
 3	Switching	Channel 1	1-bit	1,001	C, W, -, (R) 2
Description	1-bit object for switching the dimming channel on or off ("1" = switch on; "0" = switch off).				

Object	Function	Name	Type	DPT	Flag
Function: Channel relative speed adjustment (dimming)					
 6	Dimming	Channel 1	4-bit	3,007	C, W, -, (R) 2
Description	4-bit object for relative dimming of a dimming channel.				

1: For reading, the R-flag must be set. The last value written to the object by the device will be read out.

2: For reading, the R-flag must be set. The last value written to the object via the bus will be read.

Function: Channel absolute speed adjustment (dimming)

Object	Function	Name	Type	DPT	Flag
 ⁷	Speed	Channel 1	1 byte	1,003	C, W, -, (R) ₁

Description 1-byte object for specifying an absolute speed (value 0...255) from the bus.

Function: Switching feedback

Object	Function	Name	Type	DPT	Flag
 ⁸	Switching feedback	Channel 1	1-bit	1,001	C, -, T, (R) ₂

Description 1-bit object for feedback signalling of the switching state ("1" = on / "0" = off) to the bus.

Function: Feedback of absolute speed

Object	Function	Name	Type	DPT	Flag
 ⁹	Feedback of speed	Channel 1	1 byte	5,001	C, -, T, (R) ₂

Description 1-byte object for feedback signalling of a set speed (value 0...255) to the bus.

Function: Staircase function

Object	Function	Name	Type	DPT	Flag
 ⁴	Staircase function start / stop	Channel 1	1-bit	1,010	C, W, -, (R) ₁

Description 1-bit object to activate or deactivate the switch-on time of the staircase function ("1" = switch-on / "0" = switch-off).

Function: Staircase function

Object	Function	Name	Type	DPT	Flag
 ⁵	Staircase time factor	Channel 1	1 byte	5,010	C, W, -, (R) ₁

Description 1-byte object to specify a time factor for the switch-on time of the staircase function (value range: 0 ... 255).

Function: Disabling function

Object	Function	Name	Type	DPT	Flag
 ¹⁰	Disabling	Channel 1	1-bit	1,003	C, W, -, (R) ₁

Description 1-bit object for disabling the dimming channel (polarity configurable).

1: For reading, the R-flag must be set. The last value written to the object via the bus will be read.

2: For reading, the R-flag must be set. The last value written to the object by the device will be read out.

Function:	Forced position function				
Object	Function	Name	Type	DPT	Flag
 ¹¹	Forced position	Channel 1	2-bit	2,001	C, W, -, (R) ₁
Description	2-bit object for the forced position of the dimming channel. The polarity is fixed by the telegram.				

Function:	Scenes				
Object	Function	Name	Type	DPT	Flag
 ¹²	Scene extension	Channel 1	1 byte	18,001	C, W, -, (R) ₁
Description	1-byte object for recalling scenes or for storing new scene values.				

Function:	Logic operation function				
Object	Function	Name	Type	DPT	Flag
 ¹³	Logic operation	Channel 1	1-bit	1,002	C, W, -, (R) ₁
Description	1-bit object for the input of the logical link of the dimming channel. After bus voltage return or after programming with the ETS, the object value can be predefined for each parameter.				





Function:	Short-circuit monitoring				
Object	Function	Name	Type	DPT	Flag
 ¹⁴	Signalling short-circuit	Channel 1	1-bit	1,005	C, -, T, (R) ₂
Description	1-bit object for signalling short-circuit in relation to the dimming channel. ("1" =short-circuit present, "0" = short-circuit not present).				

Function:	Operating hours counter				
Object	Function	Name	Type	DPT	Flag
 ¹⁶	Limit value / starting value operating hours counter ³	Channel 1	2 byte	7,007	C, W, -, (R) ₁
Description	2-byte object for external specification of a limit value / starting value of the operating hours counter of the dimming channel. Value range: 0... 65535				

1: For reading, the R-flag must be set. The last value written to the object via the bus will be read.

2: For reading, the R-flag must be set. The last value written to the object by the device will be read out.

3: Threshold value object or start value object depending on the configured counter type of the operating hours counter.

Object	Function	Name	Type	DPT	Flag
Function: Operating hours counter					
 17	Restart op. hours counter	Channel 1	1-bit	1,015	C, W, -, (R) 1
Description	1-bit object for resetting the operating hours counter of the dimming channel ("1" = restart, "0" = no reaction).				
Function: Operating hours counter					
 18	Value operating hours counter	Channel 1	2 byte	7,007	C, -, T, (R) 2
Description	2-byte object to transmit or read out the current counter level of the operating hours counter. If the bus voltage should fail, the value of the communication object is not lost and is actively transmitted to the bus after bus voltage return or an ETS programming operation. In the as-delivered state, the value is "0".				
Function: Operating hours counter					
 19	Operating hrs counter elapsed	Channel 1	1-bit	1,002	C, -, T, (R) 2
Description	1-bit object to sign that the operating hours counter has elapsed (forwards counter = limit value reached / backwards counter = value "0" reached). With a message, the object value is actively transmitted to the bus ("1" = message active / "0" = message inactive). If the bus voltage should fail, the value of the communication object is not lost and is actively transmitted to the bus after bus voltage return or an ETS programming operation.				
Function: Load type feedback					
 20	Signalling load type	Channel 1	1 byte	20.xxx	C, -, T, (R) 2
Description	1-byte object for signalling the set load type of the dimming channel. "2" = leading edge phase control (preselected dimming principle for the speed controller) "0, 1, 3...255" not used				

1: For reading, the R-flag must be set. The last value written to the object via the bus will be read.

2: For reading, the R-flag must be set. The last value written to the object by the device will be read out.

4.2.4 Functional description

4.2.4.1 Description of channel-independent functions

4.2.4.1.1 Channel definition

There are up to 4 dimming channels available depending on the device variants. To increase the channel dimmer output power, the "4-gang" device variant in particular can be wired in parallel by reducing the number of channel outputs. The assignment of parallel to wired dimming outputs to the KNX-controllable dimming channels takes place in the ETS.

- i** The configuration of the dimming channels has influence on the use of the 4 dimmer outputs and thus influence on the load distribution.

In the ETS on the parameter page "Channel definition", the number of dimming channels to be used is selected. The fewer channels that are configured, the more dimming outputs can be assigned to a channel. The assignment of the KNX controllable dimming channels to the dimming outputs is described in the assignment table (Figure 10), which is also stored in the device.

The assignment of dimming channel 1 to the outputs can be configured in 2-channel and 3-channel operation. This then gives rise to the effect of the other channels on the outputs in accordance with the channel assignment table. The "Effect of channel 1" parameter defines the assignment and, irrespective of this, specifies the effect of the other channels.

Number of channels	Output 1	Output 2	Output 3	Output 4
Channel 1...4	Channel 1	Channel 2	Channel 3	Channel 4
Channel 1...3	Channel 1		Channel 2	Channel 3
Channel 1...3	Channel 1	Channel 2	Channel 3	
Channel 1...2	Channel 1		Channel 2	
Channel 1...2	Channel 1	Channel 2		
Channel 1...2	Channel 1			Channel 2
Channel 1	Channel 1			

Figure 10: Channel assignment table
Options of the channel assignment depending on the number of channels

- i** Parallel wired outputs can only be utilized up to a max of 95 % each.
 -> 2 outputs in parallel: Maximum connected load 475 W!
 -> 3 outputs in parallel: Maximum connected load approx. 710 W!
 -> 4 outputs in parallel: Maximum connected load 950 W!
- i** In the case of parallel wiring of dimming outputs, it is not permitted to connect additional power extensions to the load outputs concerned!
- i** Do not connect any HV-LED lamps, LV-LED lamps or compact fluorescent lamps to dimmer outputs switched in parallel.

- i With the "2-gang" device variant the dimming outputs cannot be wired in parallel. Consequently, the parameters for setting the number of channels and the effect in the ETS do not exist for these device variants. The same holds true for the device variant "1-gang" since only one dimming channel is available here.
- i On the parameter page "Connection help", a summary of the channel assignment and possible connected load of the individual dimming channels is displayed. The information on this page can help the installation engineer to connect the electrical load to the dimming outputs and hence to assign it to the KNX-controllable dimming channels when installing the device.

To simplify the configuration, all existing dimming channels can be assigned to the same parameters in the ETS and thus configured identically. The parameter "Setting of the channel parameters" on the parameter page "Channel definition" specifies whether every dimming channel of the device can be configured individually or whether all channels should be configured by the same parameters.

In the "all channels equal" setting, the number of parameters in the ETS is reduced. The visible parameters are then used on all channels automatically. Only the communication objects can then be configured separately for the channels. This setting should be selected, for example, if all channels behave identically and should only be activated by different group addresses (e.g. in office blocks or in hotel rooms).

- i In the "all channels equal" setting, the number of dimming channels can only at least be reduced to the 2-channel operation.
- i In the device variant "1-gang", the parameter "Setting of the channel parameters" is not necessary because only one channel must be configured here.

4.2.4.1.2 Manual operation

All outputs of the device have electronic manual operation. The button field with 4 function keys and 3 status LEDs on the front panel of the device can be used for setting the following modes of operation...

- Bus control: operation from touch sensors or other bus devices
- Temporary manual control: manual control locally with keypad, automatic return to bus control,
- Permanent manual control: local manual control with keypad.

The operation of the function keys, the control of the outputs and the status display are described in detail in chapter "Operation" (see page 19). The parameterisation, status feedback, disabling via a bus telegram, and interaction with other functions of the device when manual control is activated and deactivated are described in greater detail below.

Manual control is possible while the device is supplied with power from the mains or bus. In the state as supplied the manual control mode is fully enabled. In this unprogrammed state, all outputs can be controlled by the manual operation so that fast function checking of the connected loads (e.g. on the construction site) is possible.

After initial commissioning of the actuator via the ETS, manual control can be enabled or disabled separately for various states of operation. Manual control can, for instance, be disabled during bus operation (bus voltage applied). Another option consists in the complete disabling of the manual control only in case of bus voltage failure. Therefore manual control can be disabled completely, if the bus disable and bus failure disable are active.

Enabling the manual control mode

Manual control for the different states of operation is enabled or disabled by means of the parameters "Manual control in case of bus voltage failure" and "Manual control during bus operation".

- Set the parameter "Manual control in case of bus voltage failure" to "enabled".
Manual control is then basically enabled when the bus voltage is off. This setting corresponds to the setting of the actuator as delivered.
 - Set the parameter "Manual control in case of bus voltage failure" to "disabled".
Manual control is completely disabled when the bus voltage is off. In this case, bus operation is not possible either so that the outputs of the actuator can no longer be activated.
 - Set the parameter "Manual control during bus operation" to "enabled".
Manual control is then basically enabled when the bus voltage is on. The outputs of the actuator can be activated via the bus or manually. This setting corresponds to the setting of the actuator as delivered.
 - Set the parameter "Manual control during bus operation" to "disabled".
Manual control is completely disabled when the bus voltage is on. In this configuration, the actuator outputs can only be operated via the bus.
- i** In the case of bus voltage failure, an active manual operation will not be terminated even if "Manual operation in case of bus voltage failure = disabled" is configured. This will be disabled later, only at the end of manual operation.
- i** Further parameters and communication objects of the manual control are visible only in the configuration "Manual control during bus operation = enabled". For this reason, the disabling function, the status message and bus control disabling can only be configured in the above parameter setting.

Presetting the behaviour at the beginning and at the end of manual control.

The manual control distinguishes the temporary and permanent manual control. The behaviour is different depending on these modes of operation, especially at the end of manual control. It should be noted that the operation via the bus, i.e. control of the outputs by direct operation (switching / dimming / brightness value, scenes, central) or by the disabling or forced position functions is always disabled when the manual control is active. This means that the manual control mode has the highest priority.

Behaviour at the beginning of manual control:

The behaviour at the beginning of manual control does not differ for temporary and permanent manual control. During activation of the manual operation, the brightness statuses of the dimming channels remain unchanged.

Flashing feature during disabling function: The flashing of a disabling function is interrupted at the beginning of the manual operation. The brightness adapts itself to the switch-on brightness. The switching status is indicated as "ON".

Active forced position functions or disabling functions can be overridden by manual control. These functions are reactivated after deactivation of the manual mode unless they have been cancelled via the bus in the meantime.

Behaviour at the end of manual control:

The behaviour at the end of manual control is different for temporary and permanent manual control.

The temporary manual mode is shut off automatically when the last output has been addressed and when the select key  is pressed once more. During a deactivation of the temporary manual operation mode, the actuator goes back to 'normal' bus operation and does not change the brightness or speed states selected by manual operation. If, however, a forced position or disabling function has been activated via the bus before or during manual operation, the actuator executes these functions of a higher priority again for the dimming channels concerned.



The permanent manual control mode is shut off, when the select key  is pressed for more than 5 seconds. Depending on the parameterization of the actuator in the ETS, the outputs will be set to the state last adjusted in the manual mode or to the state internally tracked (direct operation, forced position, disabling) when the permanent manual mode is switched off. The parameter "Behaviour at the end of permanent manual control during bus operation" defines the corresponding reaction.

- Set the parameter "Behaviour at the end of permanent manual control during bus operation" to "no change".

All telegrams received during an active permanent manual control mode for direct operation (switching, dimming, brightness value, central, scenes) will be rejected. After the end of the permanent manual operation mode, the current brightness or speed state of all channels remains unchanged. If, however, a forced position or disabling function has been activated via the bus before or during manual operation, the actuator executes these functions of a higher priority again for the channels concerned.

- Set the parameter "Behaviour at the end of permanent manual control during bus operation" to "track outputs".

During active permanent manual control all incoming telegrams  are tracked internally. At the end of manual operation, the channels are adjusted to the last tracked brightness or speed states. If a forced position or disabling function has been activated via the bus before or during manual control, the actuator executes these functions of a higher priority again for the channels concerned.

-  The behaviour at the end of the permanent manual control when the bus voltage is off (e.g. building site operation) is permanently set to "no change".
-  The control operations triggered in the manual control mode will be transmitted via feedback objects to the bus, if enabled and actively transmitting.
-  On return of bus voltage or after programming with the ETS an activated manual control mode will always be terminated. In this case, the parameterized or predefined behaviour at the end of manual control will not be executed. The actuator executes the parameterized behaviour on bus/mains voltage return or after ETS programming instead.

Presetting a manual control disable

The manual control mode can be separately disabled via the bus, even if it is already active. If the disabling function is enabled, then as soon as a disabling telegram is received via the disabling object of the manual control, the actuator immediately terminates an activated manual control and locks the function keys on the front panel of the device. The telegram polarity of the disabling object is parameterisable.

The manual control mode during bus operation must be enabled.

- Set the parameter "Disabling function manual control ?" on parameter page "Manual control" to "yes".

The disabling function of the manual control mode is enabled and the disabling object is visible.

- Select the desired telegram polarity in the "Polarity of the manual operation disabling object" parameter.

i If the polarity is "0 = disabled; 1 = enabled", the disabling function is immediately active on return of bus/mains voltage or after an ETS programming operation (object value "0"). To activate the manual control in this case, an enable telegram "1" must first be sent to the disabling object.

i In case of bus voltage failure, disabling via the disabling object is always inactive (depending on parameterization, the manual control is then either enabled or completely disabled). After return of bus voltage, a disabled state that was active beforehand is always inactive when the polarity of the disabling object is non-inverted.

i When an active manual control is terminated by a disable, the actuator will also transmit a "Manual control inactive" status telegram to the bus, if the status messaging function is enabled.

Presetting the status message function for the manual control mode

An actuator can transmit a status telegram to the bus via a separate object when the manual operation is activated or deactivated. The status telegram can only be transmitted when the bus voltage is switched on. The polarity of the status telegram can be parameterised.

The manual control mode during bus operation must be enabled.

- Set the parameter "Status manual control ?" on parameter page "Manual control" to "yes".

The status messaging function of manual control is enabled and the status object is visible.

- Specify in the parameter "Status object function and polarity" whether the status telegram is generally a "1" telegram whenever the manual control mode is activated or only in those cases where the permanent manual mode is activated.

i The status object is always "0" when the manual control mode is deactivated.

i After bus voltage return, the status will only be transmitted actively to the bus ("0") if a manual control, activated during a bus voltage failure, is ended by the bus return. The status telegram is in this case transmitted without delay.

i When active manual control is terminated by a disable, the actuator will also transmit a "Manual control inactive" status telegram to the bus.

Setting disabling of the bus control

Individual dimming channels can be disabled locally so that the connected loads can no longer be controlled via the KNX. Such disabling of the bus operation is initiated by operation in permanent manual operation and is indicated by rapid flashing of the status LEDs on the front panel of the device concerned. The disabled outputs can then only be activated in permanent manual control.

The manual control mode during bus operation must be enabled.

- Set the parameter "Bus control of single channels during bus operation can be disabled?" on parameter page "Manual control" to "yes".

The function for disabling the bus control is enabled and can be activated locally. As an alternative, this parameter can be set to "no" to prevent activation of disabling of the bus control in permanent manual control.
- ⓘ The disabling initiated locally has the highest priority. Thus all other functions of the actuator that can be activated via the bus (e.g. forced position or disabling function) are overridden. Depending on the parameterization of the actuator in the ETS, the groups will be set to the state last adjusted in the manual mode or to the state internally tracked (direct operation, forced position, disabling) when the permanent manual mode is reactivated and subsequently shut off.
- ⓘ Any disabling of the bus control activated locally is not reset after bus voltage return if the mains voltage was switched on interruption free. A failure of the bus and mains voltage or ETS programming operation always deactivates the disabling of the bus control.

4.2.4.1.3 Delay after device reset

To reduce telegram traffic on the bus line after bus voltage activation (bus reset), after connection of the device to the bus line or after programming with the ETS, it is possible to delay all actively transmitted feedback telegrams of the actuator. For this purpose, a channel-independent delay can be specified (parameter "Delay after bus voltage return" on parameter page "General". Only after the configured time elapses are feedback telegrams for initialisation transmitted to the bus.

It is possible to configure separately which of the channel-oriented feedback telegrams are actually delayed for each dimming output or for each feedback function.

- i** The delay has no effect on the behaviour of the individual dimming channel. Only the feedback telegrams are delayed. The channels can also be activated during the delay after bus voltage return.
- i** A setting of "0" for the delay after bus voltage return deactivates the delaying function altogether. In this case, all feedback telegrams, if actively transmitted, will be transmitted to the bus without any delay.
- i** All actively transmitting objects of the operating hours counter or the message objects "Load failure / overload", "short-circuit" and "Load type" are to be regarded as feedback objects. In this case, however, all feedbacks will always be transmitted with a delay, depending on the parameterisation for "Delay after bus voltage return".
- i** After bus voltage return, the message "Manual operation status" will only be transmitted actively to the bus ("0") if a manual operation, activated during a bus voltage failure, is ended by the bus return. The status telegram is in this case transmitted without delay.
- i** Depending on the system, there is always a brief delay after programming with the ETS if the "Delay after bus voltage return" is configured to "0".

Delaying a feedback

Only feedbacks that are enabled and set as actively transmitting can be configured with regard to the transmitting behaviour after bus voltage return.

- Set the parameter "Time delay for feedback telegram after bus voltage return" to "Yes". The parameter is on the parameter page of the corresponding switching status or brightness value feedback of a dimming channel.

In this case, after bus voltage return the feedback telegram is first transmitted to the bus after the end of the delay time. Alternatively (setting "No"), a feedback telegram is transmitted to the bus without time delay immediately after bus voltage return .

4.2.4.1.4 Central function

The actuator offers the possibility of linking selected individual or all dimming channels with a 1-bit central communication object. The behaviour in case of activating a channel via the central function is comparable to a central group address linked with all "Switching" objects. The dimming channels assigned to the central function are activated in accordance with the central object value received. The polarity of the central telegram can be configured as inverted. The behaviour of the channels is identical with the normal activation via the "Switch" objects. (same priority – last switching command is executed). Thus, all 'downstream' functions, such as timing/supplementary functions, are also taken into account (Figure 11).

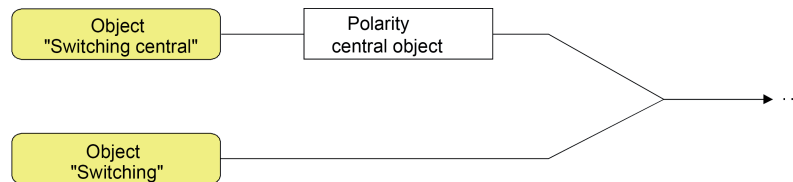

Figure 11: Function diagram "Central switching"

Enabling the central function

- Enable the central function on parameter page "General" by setting the "Central function ?" to "Yes".
If a function is active, the "Central switching" communication object is visible.

Assigning dimming channels to the central function

Each dimming channel can be assigned independently to the central function.

The central function must have been enabled on parameter page "General". The assignment has otherwise no effect on a channel.

- Set the Parameter "Assignment to central function ?" on parameter page "Kx - General" (x = number of dimming channel 1...4) to "Yes".

The appropriate dimming channel is assigned to the central function. The connected loads can be switched on or off centrally.

- i** The switching state set by the central function is tracked in the feedback objects and also transmitted to the bus, if these are actively transmitting. The switching state set by a central function is not tracked in the "switching" objects.
- i** After a bus voltage return or after programming with the ETS, the central function is always inactive (object value "0").

4.2.4.2 Channel-oriented functional description

4.2.4.2.1 Definition of the operating mode

Apart from controlling lighting, the universal dimmer actuator 1-gang can be used as a speed controller of single-phase electric motors. This operating mode can be preselected in the ETS and has a considerable effect on the parameter configuration and function of the device.

In the function as a speed controller, the dimming principle is predefined to "phase cut-on". Consequently, no load type can then be configured in the ETS. Moreover, some parameter and object texts change because the speed of a connected motor is controlled instead of brightness in the "speed controller" operating mode. The speed (e.g. minimum speed) is configured in the ETS as a percentage value. This value represents the dimming value in percent and is a gauge for the output signal's phase angle of the actuator.

The differences between the "speed controller" operating mode compared to the "lighting control" operating mode can be read in detail in the chapter "Features in the speed controller operating mode" (see page 112).

- i** The operating mode is not adjustable in the device variants "2-gang" and "4-gang". The lighting operation is always intended here.

Presetting the operating mode

The operating mode of the dimming channel is set on the "K1 - General" parameter page .

- Set the "operating mode" parameter to "Lighting control".

Lighting is connected on the dimmer output. The device permits switching and dimming of HV incandescent lamps, HV halogen lamps and LV halogen lamps with inductive transformers or Tronic-Transformers by means of conventional transformers and Tronic-Transformers. It is also possible to activate dimmable HV-LEDs or compact fluorescent lamps. If, in the ETS, Version "1.3" of the application program is used in combination with devices of the "V04" generation or higher, then LV-LEDs can also be activated via electronic or conventional transformers.

The appropriate dimming procedure can either be calibrated automatically, or alternatively, configured in the ETS (see "Type of connected load" parameter).

- Set the "operating mode" parameter to "speed controller".



An electric motor is connected on the dimmer output. The device enables the motor to be started up and switched off as well as the variation of the speed. The appropriate dimming procedure in this case is preselected automatically and cannot be altered.

- i** In the as-delivered state of the device, the "lighting control" is preconfigured as operating mode. When connecting a motor, the "speed controller" operating mode must be configured in the ETS. After the installation, commissioning using the ETS is essential before switching on the mains voltage supply (see page 16-17).

4.2.4.2.2 Definition of the load type and load type message

The device works according to the leading edge phase control or trailing edge phase control dimming principle and permits switching and dimming of HV incandescent lamps, HV halogen lamps and LV halogen lamps by means of conventional transformers and Tronic-Transformers. It is also possible to activate dimmable HV-LEDs or compact fluorescent lamps. If, in the ETS, Version "1.3" of the application program is used in combination with devices of the "V04" generation or higher, then LV-LEDs can also be activated via electronic or conventional transformers. The "1-gang" device variant can also control single-phase electric motors in the "Speed controller" operating mode.

In lighting operation, the characteristic of the connected load can automatically be calibrated separately for each dimming channel and the appropriate dimming procedure can be set. Alternatively, the dimming procedure can be predefined by a parameter in the ETS without calibration taking place. This procedure is necessary for loads that do not enable automatic calibration (e.g. with compact fluorescent lamps).

-  In the "Speed controller" operating mode, the dimming principle is preset to "leading edge phase control".
-  When selecting the appropriate dimming principle, the specifications of the lamp manufacturer should generally be observed!

Defining load type

The "Type of connected load" parameter on the parameter page "Kx - General" (x = number of dimming channel 1...4) defines the dimming procedure. This parameter is not available in the "speed controller" operating mode for the "1-gang" device variant).



CAUTION!

Risk of destruction if the preset dimming principle and connected load do not match.

The dimmer and load may be destroyed.

Before changing the dimming principle, observe load type.

Before changing the load type, make sure that the dimming principle is correct.

Before changing the load type, disconnect the mains voltage of the device and the load circuit concerned. Check parameter settings and adjust if necessary.



CAUTION!

Danger of destruction from mixed loads.

The dimmer and load may be destroyed.

Do not connect capacitive loads, e.g. electronic transformers, and inductive loads, e.g. inductive transformers, together on the same dimmer output.

Do not connect inductive transformers together with HV LED lamps or compact fluorescent lamps on the same dimmer output.

- Set the parameter to "universal (with calibration procedure)".
The dimming channel calibrates itself universally to the connected load type. After programming in the ETS, after bus voltage return, after mains voltage return on the terminal pair "L N" (without bus voltage) or after switching on the mains voltage supply of a load output, the actuator calibrates itself automatically to the connected load. The calibration procedure becomes noticeable during ohmic loads by a brief flicker and lasts up to 10 seconds depending on the network conditions.
-  This setting must not be selected for loads that do not enable automatic calibration (e.g. with compact fluorescent lamps). In this case, a suitable dimming principle must be preselected (see following settings).

- Only with application program version "1.2" and device generations up to "V03" and onwards: Set the parameter to "Electronic transformer (capacitive / trailing edge phase control)".

The dimming channel is preset to trailing edge phase control principle. There is no automatic calibration of the load type. Ohmic loads or electronic transformers can be connected to the output.
 - Only with application program version "1.3" and device generations from "V04" and onwards: Set the parameter to "Electr. transformer / LV-LED (capacitive/trailing edge phase control)".

The dimming channel is preset to trailing edge phase control principle. There is no automatic calibration of the load type. Ohmic loads, electronic transformers or LV-LEDs (via Tronic transformers) can be connected to the output.
 - Only with application program version "1.2" and device generations up to "V03" and onwards: Set the parameter to "Conventional transformer / LV-LED (inductive/leading edge phase control)".

The dimming channel is preset to leading edge phase control principle. There is no automatic calibration of the load type. Conventional transformers can be connected to the output.
 - Only with application program version "1.3" and device generations from "V04" and onwards: Set the parameter to "Conv. transformer / LV-LED (inductive/leading edge phase control)".

The dimming channel is preset to leading edge phase control principle. There is no automatic calibration of the load type. Conventional transformers or LV-LEDs (via conv. transformers) can be connected to the output.
 - Only with application program version "1.2": Set the parameter to "LED (trailing edge phase control)".

The dimming channel is preset to an optimized trailing edge phase control principle. There is no automatic calibration of the load type. HV LED or compact fluorescent lamps optimized for this dimming principle can be connected to the output.
 - Only with application program version "1.3" and device generations from "V04" and onwards: Set the parameter to "HV-LED (trailing edge phase control)".

The dimming channel is preset to an optimized trailing edge phase control principle. There is no automatic calibration of the load type. HV LED or compact fluorescent lamps optimized for this dimming principle can be connected to the output.
 - Only with application program version "1.2": Set the parameter to "LED (leading edge phase control)".

The dimming channel is preset to an optimized leading edge phase control principle. There is no automatic calibration of the load type. HV LED or compact fluorescent lamps optimized for this dimming principle can be connected to the output.
 - Only with application program versions "1.3" and device generations from "V04" and onwards: Set the parameter to "HV-LED (leading edge phase control)".

The dimming channel is preset to an optimized leading edge phase control principle. There is no automatic calibration of the load type. HV LED or compact fluorescent lamps optimized for this dimming principle can be connected to the output.
- i** In the as-delivered state of the device, the dimming principle is set to "universal" for all outputs.
- i** When changing a load type on an output, the dimming principle must also be changed if necessary!

The specifications of the lamp manufacturer can be observed in order to obtain the appropriate dimming principle for the connected lamps. The following table shows dimming principle combinations and connected load that are appropriate, not recommended and inappropriate.

ETS parameter	Load			
	Incandes. lamps HV halogen	LV halogen / LV LED via. conv. transf. (inductive)	LV halogen / LV LED via electr. transf. (capacitive)	HV LED „Retrofit“, Compact fluorescent lamps
universal	✓	✓	✓	⊗
elect. transf. / LV LED Phase cut-off	✓	⊗	✓	⊗
conv. transf. / LV LED Phase cut-on	✓	✓	⊗	⊗
(HV) LED Phase cut-off	✓	⊗	⊗	✓
(HV) LED Phase cut-on	✓	⊗	⊗	✓

✓ = Usage possible

⊗ = Usage is not possible (Possible Device damage)

Figure 12: Parameter selection "type of connected load" depending on activated load type
Use of LV-LEDs only with program version "1.3" and
from device version "V04"!

- i** Dimming results and dimming quality could vary depending on cable lengths, grid conditions and other influencing factors. Depending on the design and power rating of the lamps, the connected load of the specified values could vary. We do not assume any responsibility for the function, dimming results and dimming quality in connection with HV LED and LV LED and will not accept any liability.

Recommendation for the configuration of the dimming principle with HV-LED lamps:

With a device version "V04" or higher, the load detection can also take place automatically with HV-LEDs. As a result, we recommend, with these device versions, configuring the "Type of connected load" in the ETS to "universal" (this dimming principle also corresponds to the as-delivered state of the dimmer actuator). If automatic calibration of the load does not work or produces insufficient dimmer results, it is recommendable to operate HV-LED lamps preferably in the load type "(HV-)LED trailing edge phase control", regardless of the manufacturer's specification. This recommendation also applies to the older device versions up to "V03", which do not permit automatic calibration of HV-LEDs. The advantage of this setting lies in the fact that a dimming output can provide the maximum LED nominal load (see technical data). This is often not possible in leading edge phase control principle. Only configure the type of load in the ETS to "(HV-)LED leading edge phase control" if the operation of the connected lamps in the trailing edge phase control principle is not satisfactory (e.g. dimming range is too small). Protection functions (over-voltage switch-off) ensure that the device is not destroyed if the connected LED lamps are controlled in a dimming principle that the manufacturer has not designed them for (see page 27).

Problem resolution with HV-LED lamps:

Possible problems during operation of HV-LED lamps and their remedial measures are demonstrated in the following...

Parameter setting "(HV-)LED trailing edge phase control" ->

Problems:

- Dimming range too small
- Minimum brightness too high

- Lamps flicker
- Output switches off due to overvoltage

Remedial action:

Check operation in the leading edge phase control, reduce connected load as well if necessary, exchange lamps for another type.

Parameter setting "(HV-)LED leading edge phase control" ->

Problems:

- Lamps flicker
- Dimmer actuator overheats (output switches off due to overtemperature)
- Dimmer actuator hums

Remedial action:

Reduce connected load, check operation in the trailing edge phase control, exchange lamps for another type.

Enabling feedback of the load type

The device permits feedback of the set or calibrated load type to the bus. In this way, it is possible to identify the dimming principle according to which the dimming channel is working, even without knowing the parameter setting in the ETS. In universal operation, it is also possible to detect whether the channel has calibrated itself to leading edge phase control or trailing edge phase control operation.

Feedback of the load type is provided using the 1-byte object "Signal load type" available in each dimming channel. The object has the value encoding shown in the following table.

Object value	Meaning
0	Load type undefined (mains voltage off / short-circuit etc. /no calibration possible)
1	Load type capacitive / ohmic / (HV-)LED trailing edge phase control (set by parameter in the ETS)
2	Load type inductive / (HV-)LED leading edge phase control (set by parameter in the ETS)
3	Load type universal, successful calibration to capacitive or ohmic load
4	Load type universal, successful calibration to inductive load
5...255	Not used

Value encoding of the object "Signal load type"

- Set the parameter "Signal load type ?" on parameter page "Kx - Enabled functions" (x = number of dimming channel 1...4) to "Yes".

The telegram feedback of the load type is enabled and activated. After bus voltage return, in the case of mains voltage failure on the load and after programming in the ETS, the message telegram is transmitted actively to the bus. With the load type "universal" the telegram is additionally transmitted after each new calibration procedure (e.g. after load failure / overload or short-circuit).

- i** It should be noted that after programming in ETS, after switching on the bus voltage or mains voltage supply of the device, the "Delay after bus voltage return" configured in the ETS must have elapsed before a load type message telegram is transmitted to the bus.
- i** In the "speed controller" operating mode for the "1-gang" device variant the "inductive" load type is always signalled if the signalling object is enabled.

4.2.4.2.3 Signalling short-circuit

Short-circuit protection is integrated in the device for each output. If the device detects a short-circuit, the load is switched off automatically after 7 seconds in phase cut-off operation (capacitive and ohmic loads) or after 100 milliseconds in phase cut-on operation (inductive loads). After switching off, the actuator transmits a message telegram "Short-circuit present – 1" to the bus for the dimming channel concerned, if this message is enabled in the ETS.

Here, it is described how a short-circuit message is enabled and how the telegram transmission of this message behaves. The chapter "Fitting and electrical connection" describes in detail how to eliminate a short-circuit fault (see page 24-25).

Enabling a short circuit signal

Feedback of a short-circuit is provided using the 1 byte object "Signal short-circuit" available in each dimming channel. Using the "Signal short-circuit ?" parameter, the object can be enabled on parameter page "Kx – Enabled functions" (x = number of the dimming channel 1...4).

- Set the parameter to "Yes".

The short-circuit message is enabled and activated. After identifying a described fault, a "Short-circuit detected – 1" message telegram is sent to the bus from the actuator.

- i** In the event of a short-circuit message, the actuator sets the switching status to "OFF" and the status of the brightness value to "0" and transmits these values to the bus if enabled in the ETS.
- i** When switching on the mains voltage on the load after eliminating the fault, the actuator transmits a message telegram "no short-circuit – 0" to the bus after 7 seconds in phase cut-off operation and after 100 milliseconds in phase cut-on operation. Otherwise, a short-circuit message is transmitted again.
- i** The actuator initialises the objects "Signal short-circuit" of all dimming channels after an ETS programming operation or after switching on the bus voltage according to their current status. In this case, it should be noted that the "Delay after bus voltage return" configured in the ETS must have elapsed before short-circuit message telegrams are transmitted to the bus.

4.2.4.2.4 Signalling load failure / overload

The device with a lighting control can monitor the electric circuits of its load outputs independent of each other. The actuator detects the mains voltage supply failures (> 15 seconds) of an output or the interruption of the electric circuit when a load is switched on or off. The load failure detection can be enabled separately in the ETS for each dimming channel.

If there is an over-temperature in the device, the load is switched off by the temperature control of the device. The actuator, 15 seconds after switching off, transmits a message telegram "Load failure present – 1" to the bus for the dimming channel concerned, if this message is enabled in the ETS. In this state, the dimming channel concerned can no longer be switched on by manual or bus control. To reset such a fault, it might be necessary to switch off the mains voltage supply of the load outputs. Over-temperatures in the device either occur as a result of self-heating (electrical overload) or external influences (ambient temperature in the control cabinet is too high).

The device is also protected against electrical overload. Electrical overloads occur when the nominal operation parameters of a dimmer output are exceeded temporarily or continuously. The reaction of a device then depends on how great the electrical overload is and which ambient conditions prevail.

If the overload exceeds the defined short-circuit threshold, the device switches off the dimming channel concerned after 7 seconds at the latest, depending on the load type. In this case, the actuator generates a short-circuit message on the bus if this feedback is enabled in the ETS. If the electrical overload does not exceed the short-circuit threshold, the device heats up continuously. Whether and how rapidly this self-heating occurs depends essentially on how great the overload is and how much the device is thermally influenced from outside. The heating up of the device causes the over-temperature switch-off to take effect from a specific temperature threshold. In this case, the actuator generates a load failure message on the bus if this feedback is enabled in the ETS.

Consequently, the device protects itself constantly by means of short-circuit or over-temperature switch-off even in the case of an electrical overload.

Here, it is described how a load failure/overload message is enabled and how the telegram transmission of this message behaves. The chapter "Fitting and electrical connection" describes in detail which events cause a load failure or overload and how to eliminate these faults.

- i No message of a load failure is possible for the "1-gang" device variant in the "speed controller" operating mode and for the "4-gang" device variant with "parallel wired outputs". No load failure message can be configured in the ETS in this case.

Enabling the signalling of a load failure / overload

Feedback of a load failure or overload is provided using the 1 bit object "Signal load failure / overload" available in each dimming channel. Using the "Signal load failure / overload ?" parameter, the object can be enabled on parameter page "Kx – Enabled functions" (x = number of the dimming channel 1...4).

- Set the parameter to "Yes".

The load failure/overload message is enabled and activated. A message telegram "Load failure/overload detected – 1" is transmitted from the actuator to the bus approx. 15 ...20 seconds after identification of a load failure or overload. A mains voltage failure of the output is always detected as load failure if the mains voltage failure lasts longer than approx. 15 seconds.

- i In the event of a load failure or overload, the actuator sets the switching status to "OFF" and the status of the brightness value to "0" and transmits these values to the bus if enabled in the ETS.

- i The actuator initialises the objects "Signal load failure / overload" of all dimming channels according to their current status after an ETS programming operation or after switching on the bus voltage. In this case, it should be noted that the "Delay after bus voltage return" configured in the ETS must have elapsed before load failure/overload message telegrams are transmitted to the bus.
- i At least 15 seconds after switching on the mains voltage, the actuator transmits a message telegram "no load failure / no overload – 0" to the bus if the fault was eliminated. Otherwise, a load failure/overload message is transmitted again. No message telegram is transmitted within the "Delay after bus voltage return".

4.2.4.2.5 Definition of the brightness range

The brightness range, adjustable by switching or dimming procedures, can be limited by defining a lower and upper brightness value. The lower brightness value is either defined by the basic brightness, or alternatively, by the minimum brightness. The upper brightness value is always characterised by the maximum brightness.

The maximum brightness adjustable in the ETS is never exceeded in the switched-on operating state of a dimming channel under any circumstances. Neither when switching on nor when dimming. The maximum brightness value can be reduced for energy saving reasons, for example. In combination with some power extensions, it may also be necessary to reduce the maximum brightness (please observe the documentation of the power extensions and notes in the chapter "Fitting and electrical connection" in this documentation!).

Furthermore, the brightness value, which should be set whenever switching on via the "switching" or "central switching" object or by manual operation on the dimming channel, can be predefined. This switch-on brightness must always be between the upper and lower brightness limit value of the dimming range.

The adjustable characteristics of the lower brightness value in the ETS differ as follows...

- Definition of the lower brightness limit with basic brightness (Figure 13):
The "basic brightness" parameter of the parameter page "Kx – General" (x = Number of the dimming channel 1...4) predefines the lower brightness threshold by adapting to the lamps. The basic brightness can be set to one of 8 step values and is a gauge for the minimum adjustable residual phase angle of the output signal in relation to the decimal brightness values "1", "2" and "3" (percentage: ~0.4 ... 1 %). The basic brightness can be undershot only by switching off.
The configurable basic brightness enables the dimming signal to be adjusted in the smallest possible dimmer setting to the lamp used. The basic brightness should be set to a step value at which the lamp at the smallest brightness value will still light up at an adequate level of brightness so that it is detected as switched on. A recommendation for incandescent lamps and standard halogen lamps is given in the ETS as an adjustment aid.

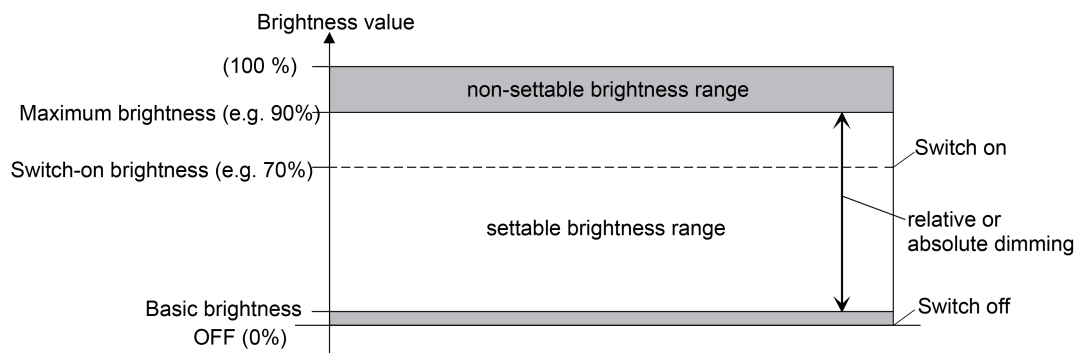

Figure 13: Example of a brightness range with basic brightness

- Definition of the lower brightness limit with minimum brightness (Figure 14):
The "minimum brightness" parameter of the parameter page "Kx – General" (x = Number of the dimming channel 1...4) predefines a lower brightness threshold in the percentage range 1 % ... 45 % (decimal "3" ... "115") in stages. The minimum brightness cannot be undershot in any switched-on operating state of the dimming channel. An undershot is only possible by switching off.
The brightness of the controlled lamps can be adapted individually – even to the brightness sensitivity of the human eye - by using the minimum brightness.

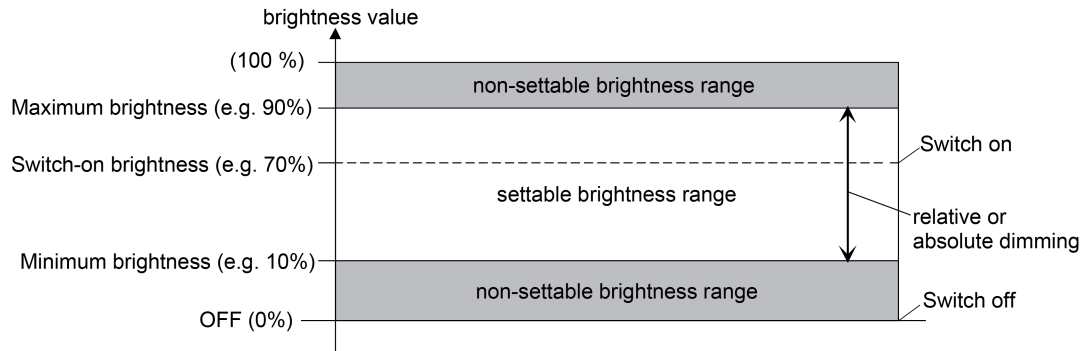

Figure 14: Example of a brightness range with minimum brightness

- i** In the "speed controller" operating mode for the "1-gang" device variant - similar to the description of the brightness values for lighting control in this chapter - the minimum speed can be configured in the ETS (Figure 14). The alternative configuration of a basic speed is not provided here for technical reasons. The maximum speed cannot be adjusted by means of a parameter either. It is predefined to 100 %. The cutting-in speed is unalterably preselected to a maximum speed (100 %).
The differences between the "speed controller" operating mode compared to the "lighting control" operating mode can be read in detail in the chapter "Features in the speed controller operating mode" (see page 112).

Adjusting basic brightness

The basic brightness can be set separately for each dimming channel.

The "Definition of the brightness range" parameter is configured to "with basic brightness".

- Set the "basic brightness" parameter on parameter page "Kx - General" (x = number of dimming channel 1...4) to the required step value.

The set step value, which is a gauge for the smallest adjustable residual phase angle of the output signal, is set to the decimal brightness values "1", "2" and "3" and therefore cannot be undershot in any switched-on operating state of the dimming channel.

- i** The parameter should be set in such a way that the lamp will still light up at the lowest dimmer setting.
- i** When operating a Universal Power booster on the dimmer output (see parameter "Operation with universal power booster ?") the level 1" can be set but has no effect. If the parameter should be set to level 1 in this case, the device executes level 2 as basic brightness.

Setting the minimum brightness

The minimum brightness can be set separately for each dimming channel.

The "Definition of the brightness range" parameter is configured to "with minimum brightness".

- Set the "minimum brightness" parameter on parameter page "Kx - General" (x = number of dimming channel 1...4) to the required brightness value.

The set brightness is not undershot in any switched-on operating state.

- i** The selection of the adjustable value is upwardly limited to 45 %. Greater values cannot be configured because otherwise the adjustment range of the maximum brightness will be cut (minimum brightness < maximum brightness).

- i** The ETS does not check all configured brightness values of a channel during the editing of the minimum brightness (e.g. switch-on brightness, scene values)! If values that are smaller than the configured minimum brightness are predefined by the ETS configuration, the actuator sets the minimum brightness as brightness value later during operation. The same holds true if the actuator receives values via the brightness object during operation, which undershoots the minimum brightness.

Setting the maximum brightness

The maximum brightness can be set separately for each dimming channel.

- Set the "maximum brightness" parameter on parameter page "Kx - General" (x = number of dimming channel 1...4) to the required brightness value.
The set brightness is not undershot in any switched-on operating state of the dimming channel.
- i** The selection of the adjustable value is downwardly limited to 50 % when using a minimum brightness. Smaller values cannot be configured in this case because otherwise the adjustment range of the minimum brightness will be cut (minimum brightness < maximum brightness).
- i** The ETS does not check all configured brightness values of a channel during the editing of the maximum brightness (e.g. switch-on brightness, scene values)! If values that are greater than the configured maximum brightness are predefined by the ETS configuration, the actuator sets the maximum brightness as brightness value later during operation. The same holds true if the actuator receives values via the brightness object during operation, which exceed the maximum brightness.
- i** When extending the power of an output of a dimming channel from our company by means of universal power extensions, the maximum brightness (ETS parameter) must be reduced to 90 % at most!

Setting the switch-on brightness

The switch-on brightness can be set separately for each dimming channel.

- Set the "switch-on brightness" parameter on parameter page "Kx - General" (x = number of dimming channel 1...4) to the required brightness value.
The set brightness is set after receipt of an ON telegram via the "Switching" communication object or by switching on by the manual operation on the dimming channel. Furthermore, the configured switch-on brightness is set with the "activated" polarity after receipt of a central telegram.
- Alternatively, set the parameter "Switch-on brightness" to "Memory value (brightness before switching off last time)".
When switching on, the active and internally saved brightness value prior to switching off last time is set (via the "switching" or "central switching" object). After programming with the ETS, the value is predefined to maximum brightness. Only a bus voltage failure will not delete the memory value, however.
- i** If the configured switch-on brightness is greater than the configured maximum brightness, the actuator sets the maximum brightness as the new brightness value for the dimming channel concerned when switching on (minimum brightness < switch-on brightness < maximum brightness).
- i** A memory value is also then saved internally by a switch-off telegram if the bus-controlled switch-off is overridden, for example, by a disable or forced position function or by a manual operation. In this case, the internally tracked brightness value is saved as memory value.

- i** If no soft ON function is activated, the brightness value is jumped to when switching on. Once a soft ON function is activated, the switch-on brightness is dimmed according to the dimming speed for the soft ON function.
- i** The switch-on speed is not configurable in the "speed controller" operating mode for the "1-gang" device variant. Additional differences between the "speed controller" operating mode compared to the "lighting control" operating mode can be read in detail in the chapter "Features in the speed controller operating mode" (see page 112).

Operation with universal power booster

To increase the connected load, Universal power boosters can be connected to the device. Universal power boosters are devices that supply themselves with energy directly via components of the dimmer actuator's output signal (no neutral conductor connection available). To ensure failure-free operation, the dimmer actuator output signal must be adapted in such a way that a certain amount of residual phase angle still remains (residual cut-on or off) for the highest dimming position. This residual phase angle must be large enough to enable universal power boosters to supply themselves with energy.

If the output power is increased by means of universal power boosters, the corresponding channel configuration of the dimmer actuator must be adapted in the ETS. Based on the setting of the parameter "Operation with universal power booster ?" the dimmer actuator adjusts the output signal for using universal power boosters automatically.

- Set the parameter to "No".
No universal power booster is connected to the dimming channel. In the highest dimming position (100 % brightness value), the smallest possible residual phase angle is set on the dimmer output. As a result, the connected lighting is set to the maximum lighting level technically possible.
 - Set the parameter to "Yes".
At least one universal power booster is connected to the dimming channel. In the highest dimming position (100 % brightness value), a residual phase angle necessary for universal power boosters is set on the dimmer output. The output signal cut-on or cut-off in this way corresponds to a resulting brightness of approx. 90 % compared to an identically constructed dimmer actuator without a power booster. The dimmer actuator rescales the adjustable brightness range automatically for the corresponding channel so that a presetting and feedback within a range of 0...100% is still possible.
- i** Visible brightness differences between the lighting on a dimmer actuator output without power booster and a dimmer actuator with power booster are possible.
 - i** Choose power boosters that are suitable for the dimmer and load! For additional information, please always refer to the instructions for the power extensions in question.
 - i** When using conventional power boosters for leading edge phase control or trailing edge phase control principle (NV or TRONIC power boosters) it is not normally necessary to adapt the output signal of the dimmer actuator.
 - i** Power extension possible by means of our own power boosters. Do not connect any LED lamps or compact fluorescent lamps in combination with power boosters.
 - i** In the case of parallel wiring of dimming outputs, it is not permitted to connect additional power extensions to the load outputs concerned!
 - i** With the "1-gang" device variant, it is not permitted to connect additional power extensions to the power output. Consequently, the parameterisation of universal power boosters is not necessary in this case.

4.2.4.2.6 Response after a device reset

The switching states or brightness values of the dimming channels after a bus voltage failure, bus or mains voltage return or after ETS programming can be preset separately.

- i** In the "speed controller" operating mode for the "1-gang" device variant - similar to the description of the brightness values for lighting control in this chapter - the speed values can be configured in the ETS. The differences between the "speed controller" operating mode compared to the "lighting control" operating mode can be read in detail in the chapter "Features in the speed controller operating mode" (see page 112).

Presetting the behaviour after ETS programming

The parameter "Behaviour after ETS programming" is preset separately for each dimming channel on the parameter page "Kx General" (x = number of the dimming channel 1...4). This parameter can be used to configure the brightness behaviour of a channel irrespective of the behaviour after a bus or mains voltage return.

- Set the parameter to "no reaction".
After an ETS programming operation, the dimming channel shows no response and remains in the switching brightness state currently selected or is switched off.
- Set the parameter to "switch off".
The dimming channel is switched off after a programming in the ETS.
- Set parameter to a brightness value.
The dimming channel is set to the predefined brightness value. It is important that the configured value does not undershoot the set minimum brightness (if present) or exceed the maximum brightness.
- i** The configured behaviour will be executed after every application or parameter download by the ETS. A simple download of the physical address alone or partial programming of only the group addresses has the effect that this parameter is disregarded and that the configured "Behaviour after bus or mains voltage return" will be executed instead. Furthermore, the behaviour will only then be executed if the bus and mains voltage are switched on after programming.
- i** An ETS programming operation can also be performed without mains voltage. The mains voltage supply is not required for an ETS download.
- i** The actuator briefly initialises after each ETS programming operation. Dimming channels whose load type is configured to "universal" calibrate themselves to the load. The calibration procedure becomes noticeable during ohmic loads by a brief flicker and lasts up to 10 seconds depending on the network conditions.
- i** A switching state and brightness value set after an ETS programming cycle is added to the feedback objects. Actively transmitting feedback objects also only first transmit after an ETS programming cycle when the initialisation has finished and, if necessary, the "delay time after bus voltage return" has elapsed.
- i** In the "no reaction" setting: After the programming operation, a brief switch-off occurs during the initialisation phase of the actuator. Afterwards, the brightness value that was active before is then reset again.
- i** An active manual mode will be terminated by an ETS programming operation.
- i** After an ETS programming operation, the disabling functions and the forced-positions are always deactivated. The brightness values and forced position objects saved in case of the bus voltage failure are deleted.

Presetting the behaviour in case of bus voltage failure

The parameter "Behaviour in case of bus voltage failure" can be preset separately for each dimming channel under "Kx - General" (x = number of dimming channel 1...4).

- Set the parameter to "no reaction".
In case of bus voltage failure, the dimming channel shows no reaction and remains in the currently set brightness state, provided that the mains voltage on the dimming outputs is still switched on.
 - Set the parameter to "switch off".
The dimming channel is switched off in the case of bus voltage failure. It should be noted that the configured OFF command can only be executed if the mains voltage supply of the actuator (terminal pair "L N") is switched on. If the mains voltage is switched off, the actuator in this configuration shows no reaction (the last brightness state remains active) provided that the mains voltage on the dimming outputs is still switched on.
 - Set parameter to a brightness value.
The dimming channel is set to the predefined brightness value. It should be noted that the brightness value can only be set if the mains voltage supply of the actuator (terminal pair "L N") is switched on. If the mains voltage is switched off, the actuator in this configuration shows no reaction (the last brightness state remains active) provided that the mains voltage on the dimming outputs is still switched on.
The configured value must not undershoot the set minimum brightness (if present) or exceed the maximum brightness.
 - ❏ Active disabling functions or forced position functions are cancelled and remain inactive until they are reactivated.
 - ❏ In case of a bus voltage failure, the current states of the forced-positions are also saved so that they can be tracked on return of bus voltage if necessary (depending on the parameterization of the forced positions).
 - ❏ In case of a bus voltage failure, the current brightness values of all dimming channels are permanently saved internally so that these brightness values can be reset after bus voltage return or mains voltage return (without bus) if this is configured in the ETS. The data are stored before the reaction parameterized for the case of bus voltage failure takes place and only if one part of the supply (mains or bus) is still present, or if the supply fails completely after the bus / mains voltage has been available before without interruption for at least 20 seconds after the last reset (storage capacitors sufficiently charged for storage purposes). In all other cases nothing is stored (Brightness value = "0")!
- The saving process is performed only once after the failure of one part of the supply voltage...
- Bus voltage failure -> Data storage -> Then mains voltage failure -> No further data storage.
- Because the brightness values are saved only once in the event of bus voltage failure, values that are changed after a bus voltage failure, for example via manual control, are not tracked!
- ❏ If the bus voltage fails while a manual operation on the device is activated, the parameter "Behaviour in case of bus voltage failure" is not executed.

Behaviour after bus or mains voltage return presetting

The parameter "Behaviour after bus or mains voltage return" can be preset separately for each dimming channel on the parameter page "Kx General" (x = number of the dimming channel 1...4). This parameter will always be executed on return of bus voltage only if the mains voltage (without bus) is switched on. If the mains voltage is switched on when the bus voltage is present, the actuator does not execute any particular reaction.

- Set the parameter to "no reaction".
After bus or mains voltage return, the dimming channel shows no response and remains in the brightness state currently selected or is switched off.
- Set the parameter to "switch off".
The dimming channel is switched off after bus/mains voltage return.

- Set parameter to a brightness value.
The dimming channel is set to the predefined brightness value. It is important that the configured value does not undershoot the set minimum brightness (if present) or exceed the maximum brightness.
- Set parameter to "brightness value before bus voltage failure".
After bus or mains voltage return, the brightness value last set before bus voltage failure and internally stored on bus voltage failure will be tracked.
- Set parameter to "Activate staircase function" "Activate time dimmer function".
The staircase function / time dimmer function is – irrespective of the "Switching" object - activated after bus or mains voltage return. With this setting, make sure that the staircase function / time dimmer function is also enabled in the configuration of the dimming channel. When the function is not enabled, there is no reaction after bus/mains voltage return with this setting.
- ❗ In all settings: When the bus voltage is switched on, the brightness value is set to "0 %" if no mains voltage is switch on at the time of bus voltage return on the load outputs.
- ❗ Setting "brightness value as before bus/mains voltage failure": An ETS programming operation of the application or the parameter resets the stored switching state to "off - 0".
- ❗ In the "No reaction" setting: On return of bus voltage with permanently switched on mains voltage, the corresponding dimming channel shows no response and remains in the brightness state last selected
When the bus voltage is switched on (without switching on the bus voltage), the actuator sets the brightness value "0" on the corresponding channels.
- ❗ The actuator briefly initialises after switching on the mains voltage each time. Dimming channels whose load type is configured to "universal" calibrate themselves to the load. The calibration procedure becomes noticeable during ohmic loads by a brief flicker and lasts up to 10 seconds depending on the network conditions.
- ❗ A switching state and brightness value set after bus voltage return is tracked in the feedback objects. Actively transmitting feedback objects first transmit, however, after bus or mains voltage return when the initialisation of the actuator has finished, and if necessary the "delay time after bus voltage return" has elapsed.
- ❗ In the case of forced position as supplementary function: The communication object of the forced position can be initialised separately after bus voltage return. This has an effect on the reaction of the dimming channel when the forced position is activated. The configured "Behaviour in the case of bus or mains voltage return" will only be executed if no forced position is activated after bus voltage return.
- ❗ In the case of enabling function as supplementary function: Active disabling functions are always inactive after bus voltage return.
- ❗ After return of bus voltage a manual control will be interrupted..

4.2.4.2.7 Feedback for switching status and brightness value

The actuator can track the current switching state and brightness value of a dimming channel via separate feedback objects and can also transmit them to the bus, if the bus voltage is on. The following feedback objects can be enabled independently of each other for each channel ...

- Feedback switching status (1 bit)
- Feedback brightness value (1 byte)

The actuator calculates the object value of the feedback objects during each switching or dimming procedure. The actuator tracks the switching state or brightness value and updates the feedback objects even when a dimming channel is activated by the manual operation or scene function.

The switching status feedback object is updated after the following events...

- Immediately after switching on a dimming channel (if necessary, first after a switch-on delay has elapsed and at the beginning of a soft ON dimming procedure / also after a staircase function).
- After switching off a dimming channel (if necessary, first after a run-on-time has elapsed and at the end of a soft OFF dimming procedure / also after a staircase function).
- Immediately after switch-off by the automatic switch-off function.
- At the beginning of a dimming procedure when dimming on (relatively high dimming or brightness value = 1...100 %) a dimming channel.
- At the end of a dimming procedure when dimming off (brightness value = 0 %) a dimming channel.
- Only when the switching state changes (therefore not for dimming procedures that do not change the switching state e.g. from 10 % to 50 % brightness).
- During updating of the switching state from "ON" to "ON" when the dimming channel is already switched on.
- During updating of the switching state from "OFF" to "OFF" when the dimming channel is already switched off.
- Always at the start or end of a disabling or forced position function (only if the switching state changes as a result).
- Always after bus voltage return, in the case of mains voltage failure ("OFF") or at the end of any ETS programming process (if necessary also delayed and after calibration of the load).

The brightness value feedback object is updated after the following events...

- At the end of a relative (4-bit) or absolute (1-byte) dimming procedure.
- After switching on a dimming channel, if the switch-on brightness is set (if necessary, first after a switch-on delay has elapsed and at the end of a soft ON dimming procedure / also after a staircase function).
- After switching off a dimming channel (if necessary, first after a run-on-time has elapsed and at the end of a soft OFF dimming procedure / also after a staircase function).
- Immediately after switching off by means of the automatic switch-off function.
- Only if the brightness value changes (if a brightness value specification undershoots the minimum brightness as a result of relative or absolute dimming from outside or exceeds the maximum brightness, the actuator does not update a brightness value feedback according to the minimum brightness or maximum brightness).
- Always at the start or end of a disabling or forced position function (only if the brightness value changes as a result).
- Always after bus voltage return, in the case of mains voltage failure ("0") or at the end of any ETS programming process (if necessary, also delayed and after calibration of the load)

- i** In the "speed controller" operating mode for the "1-gang" device variant - similar to the description of the brightness values for lighting control in this chapter - the speed values can be configured in the ETS. The differences between the "speed controller" operating mode compared to the "lighting control" operating mode can be read in detail in the chapter "Features in the speed controller operating mode" (see page 112).

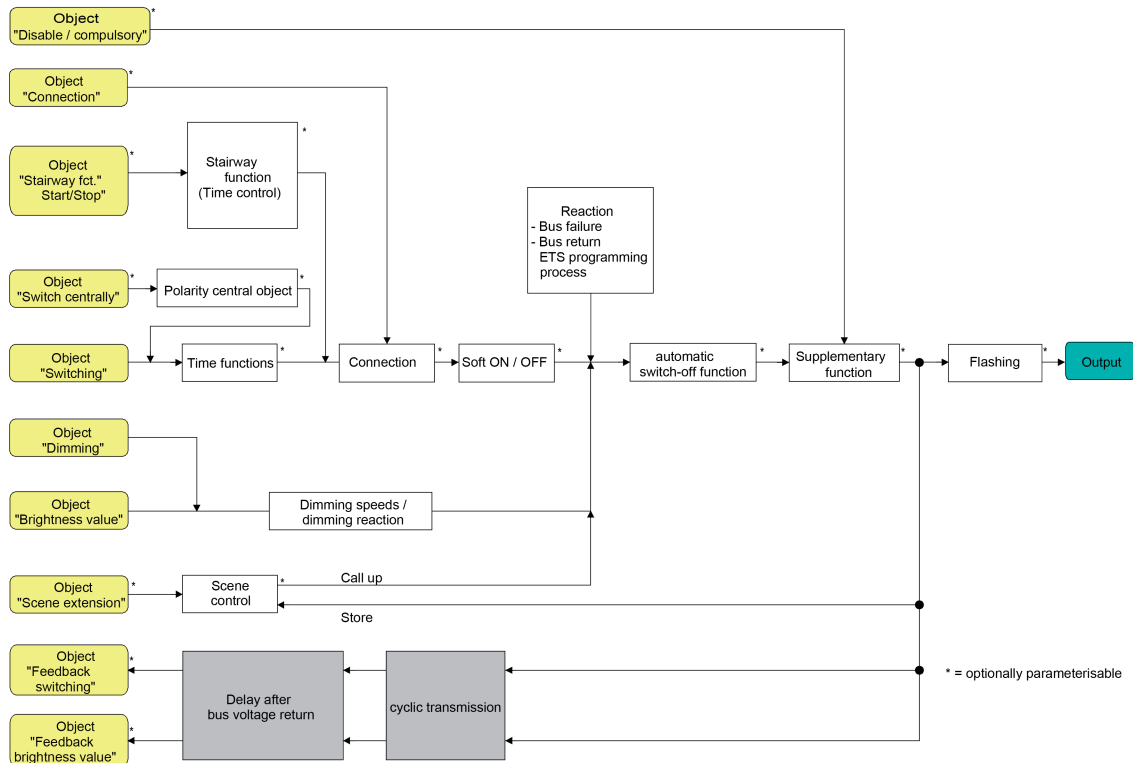

Figure 15: Functional feedback diagram of the feedbacks

- i** In the case of enabling function as supplementary function: A 'flashing' dimming channel is always signalled back as "switched on" and with switch-on brightness. Switching status feedbacks are also transmitted for disabled channels when the channels are readjusted by a manual operation, for example.

Activating switching status feedback

The switching status feedback can be used as an active message object or as a passive status object. As an active message object, the switching status feedback information is also directly transmitted to the bus whenever the feedback value is updated. As a passive status object, there is no telegram transmission after an update. In this case, the object value must be read out. The ETS automatically sets the object communication flags required for proper functioning. The parameter "Feedback switching status ?" can be preset separately for each dimming channel under "Kx - "feedbacks" (x = number of the dimming channel 1...4).

The feedbacks must be enabled on parameter page "Kx - Enabled functions".

- Set the parameter to "feedback object is active signalling object".
The "Switching feedback" object is enabled. The switching status is transmitted once the status is updated. An automatic telegram transmission of the feedback takes place after bus voltage return or after programming with the ETS.
- Set the parameter to "feedback object is passive status object".

The "Switching feedback" object is enabled. The switching status will be transmitted in response only if the feedback object is read out from by the bus. No automatic telegram transmission of the feedback takes place after bus voltage return or after programming with the ETS.

- Set the parameter to "no reaction".

The switching status feedback is deactivated.

- i** Feedback of the current switching status via the "switching" object is not possible.

Presetting update of the switching status feedback

In the ETS you can specify when the actuator should update the feedback value for the switching status in case of an actively transmitting communication object. The object value updated by the actuator is then signalled actively to the bus.

The parameter "Upgrade of the object value for feedback of switching status" can be preset separately for each dimming channel on the parameter page "Kx - "feedbacks" (x = number of the dimming channel 1...4).

The feedbacks must be enabled on parameter page "Kx - Enabled functions". In addition, the switching status feedback must either be configured to actively transmitting or passively readable.

- Set the parameter to "after each update obj. 'Switching'/'Central'".

The actuator updates the feedback value in the object once a new telegram is received on the input objects "Switching" or "Central switching". With an actively transmitting feedback object, a new telegram is also then actively transmitted to the bus each time. The telegram value of the feedback does not necessarily have to change. Hence, a corresponding switching status feedback is also generated on the "Switching" object such as in the case of cyclical telegrams.

- Set the parameter to "only if the feedback value changes".

The actuator only updates the feedback value in the object if the telegram value (e.g. "OFF" to "ON") also changes. If the telegram value of the feedback does not change (e.g. in the case of cyclical telegrams to the "Switching" object with the same telegram value), the feedback then remains unchanged. Consequently, with an actively transmitting feedback object, no telegram with the same content will be transmitted repeatedly either.

This setting is recommendable, for instance, if the "Switching" and "Switching feedback" objects are linked to an identical group address. This is often the case when activating by means of light scene push-button sensors (recall and storage function).

Activating switching status feedback on return of bus voltage or after programming with the ETS

If used as active message object, the switching status feedback information is transmitted to the bus after bus voltage return or after programming with the ETS. In these cases, the feedback telegram can be time-delayed with the delay being preset globally for all dimming channels together (see page 50).

- Set the parameter "Time delay for feedback after bus voltage return ?" on parameter page "Kx - Feedbacks" (x = number of dimming channel 1...4) to "Yes".

The switching status telegram will be transmitted with a delay after bus voltage return or after programming with the ETS. No feedback telegram is transmitted during a running delay, even if the switching state changes during this delay.

- Set the parameter "Time delay for feedback after bus voltage return ?" on parameter page "Kx - Feedbacks" (x = number of dimming channel 1...4) to "No".

The switching status telegram will be transmitted immediately after bus voltage return or after programming with the ETS.

- i** After programming with the ETS, the switching status feedback is always transmitted with a basic delay of a few seconds (initialisation procedure of the actuator / possibly calibration of the load types). The basic delay is added to the "Delay after bus voltage return" configured in the ETS, if activated.

Presetting the cyclical transmission function for the switching status feedback telegram

The switching status feedback telegram can also be transmitted cyclically via the active message object in addition to transmission after updating.

- Set the parameter "Cyclical transmission of feedback telegram?" on parameter page "Kx - Feedbacks" (x = number of dimming channel 1...4) to "Yes".
Cyclical transmission is activated.
- Set the parameter "Cyclical transmission of feedback telegram?" on parameter page "Kx - Feedbacks" (x = number of dimming channel 1...4) to "No".
Cyclical transmission is deactivated so that the feedback telegram is transmitted to the bus only when updated by the actuator.

- i** The cycle time is defined centrally for all dimming channels on the parameter page "Times".
- i** During an active delay after bus voltage return no feedback telegram will be transmitted even if a switching state changes.

Activate brightness value feedback

The brightness value feedback can be used as an active message object or as a passive status object. As an active message object, the brightness value feedback information is also directly transmitted to the bus for each update of the feedback value. As a passive status object, there is no telegram transmission after an update. In this case, the object value must be read out. The ETS automatically sets the object communication flags required for proper functioning. The parameter "Feedback brightness value ?" can be preset separately for each dimming channel under "Kx - feedbacks" (x = number of the dimming channel 1...4).

The feedbacks must be enabled on parameter page "Kx - Enabled functions".

- Set the parameter to "feedback object is active signalling object".
The "brightness value feedback" object is enabled. The brightness value is transmitted once this is updated. An automatic telegram transmission of the feedback takes place after bus/mains voltage return or after programming with the ETS.
- Set the parameter "Feedback object is passive status object".
The "brightness value feedback" object is enabled. The brightness value will be transmitted in response only if the feedback object is read out from by the bus. No automatic telegram transmission of the feedback takes place after bus voltage return or after programming with the ETS.
- Set the parameter to "no reaction".
The brightness value feedback is deactivated.

- i** A feedback of the current brightness value via the "brightness value" object – even if a Ü-Flag is set – is not possible.

Presetting update of the brightness value feedback

In the ETS you can specify when the actuator should update the feedback value for the brightness value in case of an actively transmitting communication object. The object value updated by the actuator is then signalled actively to the bus.

The parameter "Upgrade of the object value for feedback of brightness value" can be preset separately for each dimming channel on the parameter page "Kx - feedbacks" (x = number of the dimming channel 1...4).

The feedbacks must be enabled on parameter page "Kx - Enabled functions". In addition, the brightness value feedback must either be configured to actively transmitting or passively readable.

- Set the parameter to "after each update obj. brightness feedback".
The actuator updates the feedback value in the object once a new telegram is received on the input object "brightness feedback". With an actively transmitting feedback object, a new telegram is also then actively transmitted to the bus each time. The telegram value of the feedback does not necessarily have to change in the process. Hence, a corresponding brightness value feedback is also generated on the "brightness value feedback" object such as in the case of cyclical telegrams for example.
- Set the parameter to "only if the feedback value changes".
The actuator only updates the feedback value in the object if the telegram value (e.g. "0 %" to "100 %") also changes. If the telegram value of the feedback does not change (e.g. in the case of cyclical telegrams to the "brightness value" object with the same telegram value), the feedback then remains unchanged. Consequently, with an actively transmitting feedback object, no telegram with the same content will be transmitted repeatedly either.
This setting is recommendable, for instance, if the "brightness value" and "brightness value feedback" objects are linked to an identical group address. This is often the case when activating by means of light scene push-button sensors (recall and storage function).

Activating brightness value feedback on return of bus voltage or after programming with the ETS

If used as active message object, the brightness value feedback information is transmitted to the bus after bus voltage return or after programming with the ETS. In these cases, the feedback telegram can be time-delayed with the delay being preset globally for all dimming channels together (see page 50).

- Set the parameter "Time delay for feedback after bus voltage return ?" on parameter page "Kx - Feedbacks" (x = number of dimming channel 1...4) to "Yes".
The brightness value feedback will be transmitted with a delay after bus voltage return or after programming with the ETS. No feedback telegram is transmitted during a running delay, even if the brightness value changes during this delay.
 - Set the parameter "Time delay for feedback after bus voltage return ?" on parameter page "Kx - Feedbacks" (x = number of dimming channel 1...4) to "No".
The brightness value feedback will be transmitted immediately after bus voltage return or after programming with the ETS.
- i** After programming with the ETS, the brightness value feedback is always transmitted with a basic delay of a few seconds (initialisation procedure of the actuator / possibly calibration of the load types). The basic delay is added to the "Delay after bus voltage return" configured in the ETS, if activated.

Presetting the cyclical transmission function for the brightness value feedback telegram

The brightness value feedback telegram can also be transmitted cyclically via the active message object in addition to the transmission after updating.

- Set the parameter "Cyclical transmission of feedback telegram?" on parameter page "Kx - Feedbacks" (x = number of dimming channel 1...4) to "Yes".
Cyclical transmission is activated.
- Set the parameter "Cyclical transmission of feedback telegram" on parameter page "Kx - Feedbacks" (x = number of the dimming channel 1...4) to "No".
Cyclical transmission is deactivated so that the feedback telegram is transmitted to the bus only when updated by the actuator.

- i The cycle time is defined centrally for all dimming channels on the parameter page "Times".
- i During an active delay after bus voltage return no feedback telegram will be transmitted even if a brightness value changes.

4.2.4.2.8 Timing functions

Up to two time functions can be preset for each dimming channel independent of each other. The time functions affect the communication objects "switching" or "central switching" only (if a central function is activated for the channel concerned) and delay the object value received depending on the telegram polarity (Figure 16).

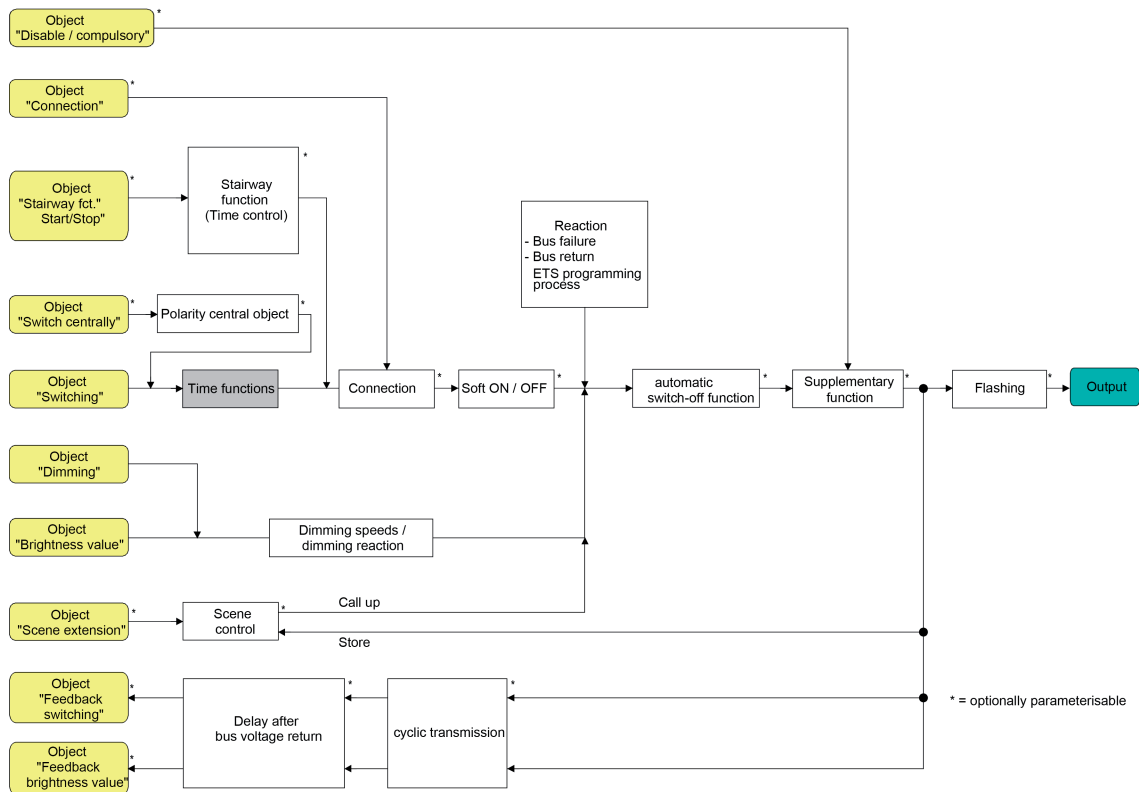

Figure 16: Function diagram of the timing functions

- i** In the "speed controller" operating mode for the "1-gang" device variant - similar to the description of the brightness values for lighting control in this chapter - speed values can be configured in the ETS. The differences between the "speed controller" operating mode compared to the "lighting control" operating mode can be read in detail in the chapter "Features in the speed controller operating mode" (see page 112).

activating switch-on delay

The switch-on delay can be activated separately in the ETS for each dimming channel.

The timing functions must be enabled on parameter page "Kx - Enabled functions".

- On parameter page "Kx – Time delays" (x = Number of the dimming channel 1...4), preset the parameter "Selection of time delay" to "Switch-on delay" or to "switch-on delay and switch-off delay". The desired switch-on delay time can be configured.

The switch-on delay is enabled. After reception of an ON telegram via the "switching" object, the configurable time is started. Another ON-telegram triggers the time only when the parameter "Switch-on delay retriggerable ?" is set to "Yes". An OFF-telegram received during the ON-delay will end the delay and sets the switching status to "OFF".

Activate switch-off delay

The switch-off delay can be activated separately in the ETS for each dimming channel.

The timing functions must be enabled on parameter page "Kx - Enabled functions".

- On parameter page "Kx – Time delays" (x = Number of the dimming channel 1...4), preset the parameter "Selection of time delay" to "Switch-off delay" or to "Switch-on delay and switch-off delay". Configure the desired switch-off delay.

The switch-off delay is enabled. After reception of an OFF-telegram via the "switching" object, the configurable time is started. Another OFF-telegram triggers the time only when the parameter "switch-off delay retriggerable ?" is set to "Yes". An ON-telegram received during the OFF-delay will end the delay and sets the switching status to "ON".

- i** Feedback: If a time delay has been preset and if the switching state is changed via the "Switching" object, the time delay must have elapsed before feedback telegrams will be transmitted.
- i** At the end of a disabling function or forced position function, the brightness state received during the function or adjusted before the function can be tracked. Residual times of time functions are also tracked if these had not yet fully elapsed at the time of the reactivation or forced control.
- i** The time delays do not influence the staircase function if this is enabled.
- i** A time delay still in progress will be fully aborted by a reset of the actuator (bus/ mains voltage failure or ETS programming).

4.2.4.2.9 Soft ON/OFF function

The soft-functions permit a dimming channel to be switched on or off at reduced speed when a switching command is received via the "Switching" or "Central switching" communication objects.

If the soft ON function is activated, a dimming procedure is executed until the switch-on brightness when switching on. This also occurs if the dimming channel is already switched on to a brightness value smaller than switch-on brightness. Likewise, with the soft OFF function, a dimming procedure is executed to 0 % brightness after receipt of an OFF telegram (Figure 17).

The dimming speeds can be configured separately in the ETS for the soft ON and soft OFF function. The relative dimming increment time between 2 of 255 dimming increments is configured directly.

The soft ON or soft OFF functions are not retriggerable by the receipt of further switching telegrams while maintaining the switching status. The soft functions can be activated and configured separately in the ETS.

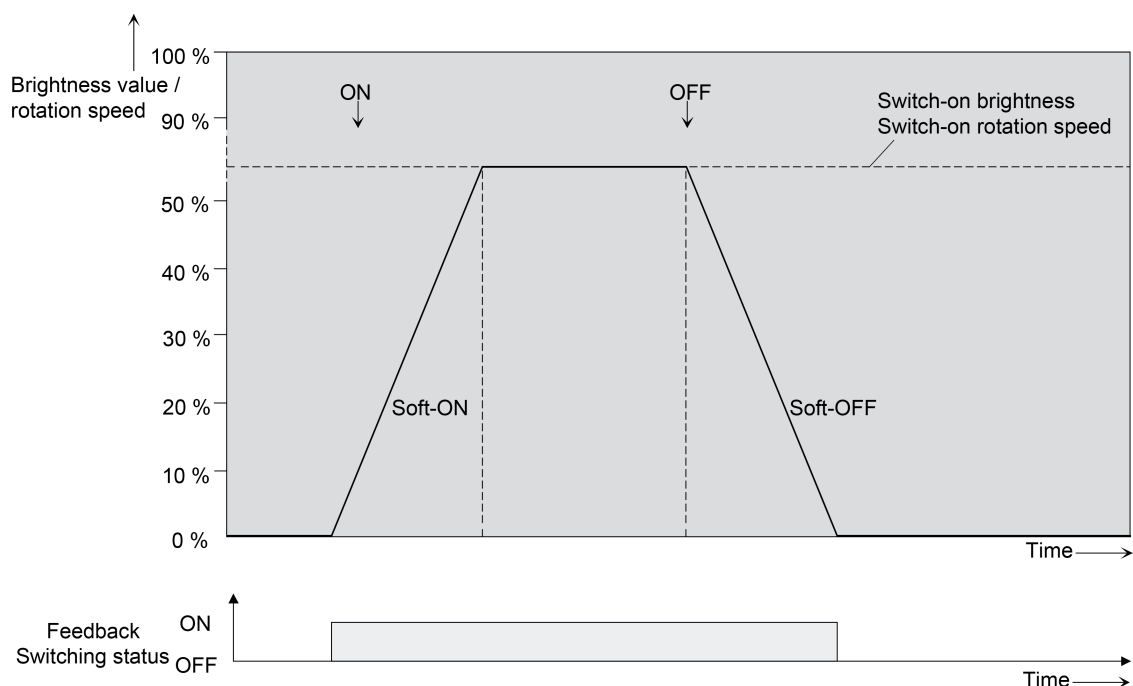

Figure 17: Dimming behaviour of the soft ON/OFF functions (as an example)

- i The soft ON function cannot be configured in the "speed controller" operating mode for the "1-gang" device variant. Additional differences between the "speed controller" operating mode compared to the "lighting control" operating mode can be read in detail in the chapter "Features in the speed controller operating mode" (see page 112).

The soft functions also have effects on the switching edges of the staircase function (Figure 18).

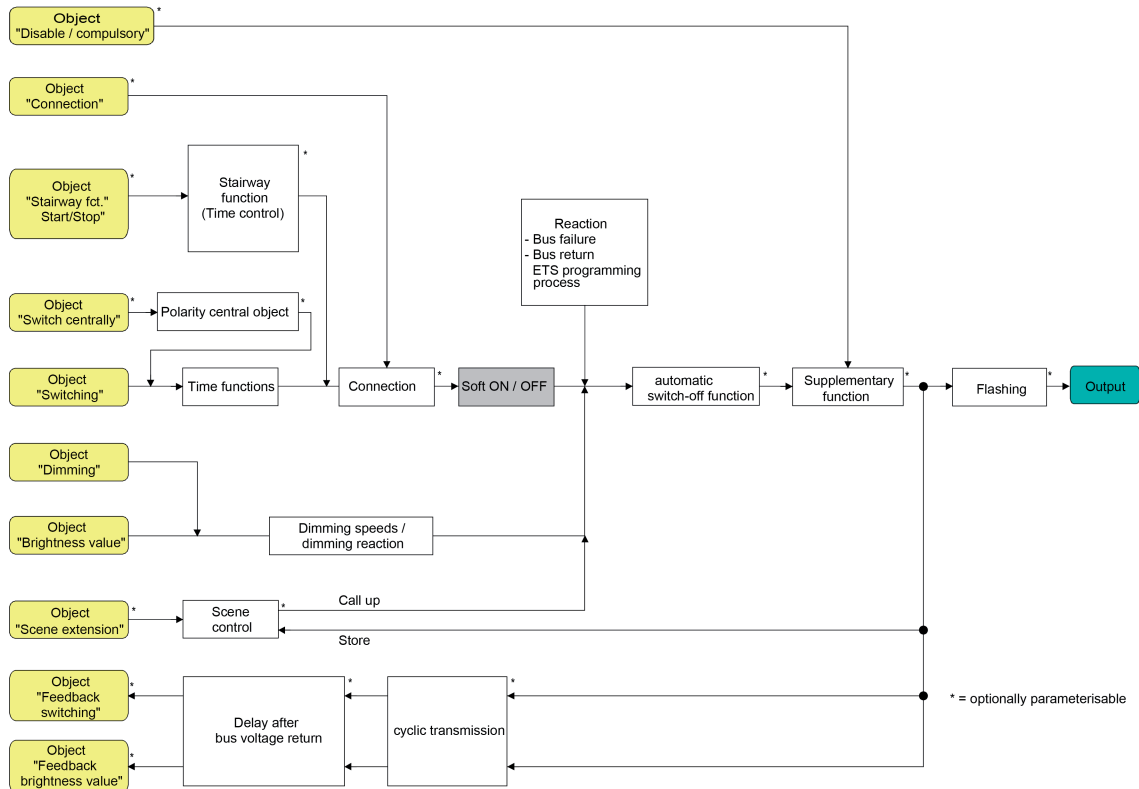

Figure 18: The function diagram of the soft functions

- i** A dimming channel disabled via the bus can also flash for the disabling function depending on the ETS configuration. Dimming is not executed with the soft functions during ON and OFF flashing.

Enabling and setting soft ON function

The soft ON function can be set separately for each dimming channel in the ETS.

The switch-on/switch-off behaviour on the parameter page "Kx - Enabled functions" (x = number of dimming channel 1...4) must be enabled.

- Set the parameter "Soft ON function ?" on the parameter page "Kx – Switch-on/switch-off behaviour" to "Yes".

The soft ON function is enabled. The parameter for the dimming increment time (time between 2 of 255 dimming increments) of the soft ON function becomes visible.

- Configure the parameter "Time for dimming increment soft ON" to the required dimming increment time.

Enabling and setting soft OFF function

The soft OFF function can be set separately for each dimming channel in the ETS.

The switch-on/switch-off behaviour on the parameter page "Kx - Enabled functions" (x = number of dimming channel 1...4) must be enabled.

- Set the parameter "Soft OFF function ?" on the parameter page "Kx – Switch-on/switch-off behaviour" to "Yes".

The soft OFF function is enabled. The parameter for the dimming increment time (time between 2 of 255 dimming increments) of the soft OFF function becomes visible.

- Configure the parameter "Time for dimming increment soft OFF" to the required dimming increment time.

4.2.4.2.10 Automatic switch-off

The switch-off function permits automatic switching of a dimming channel after a brightness value was dimmed or jumped to and this new brightness value is below a switch-off brightness set in the ETS. A time delay can be configured optionally up to switching off (cf. Fig. 10). The switch-off function is activated after reaching a constant brightness value, i.e. after a completed dimming procedure.

The automatic switch-off function, for example, not only makes it possible to set the lighting to basic brightness but to switch off as well by means of relative dimming. A further application is time-controlled 'Good night switch-off' of a dimmed children's room lighting or the automatic switching off of a fan at very low speed (in the "speed controller" operating mode).

- i** In the "speed controller" operating mode for the "1-gang" device variant - similar to the description of the brightness values for lighting control in this chapter - the speed values can be configured in the ETS.

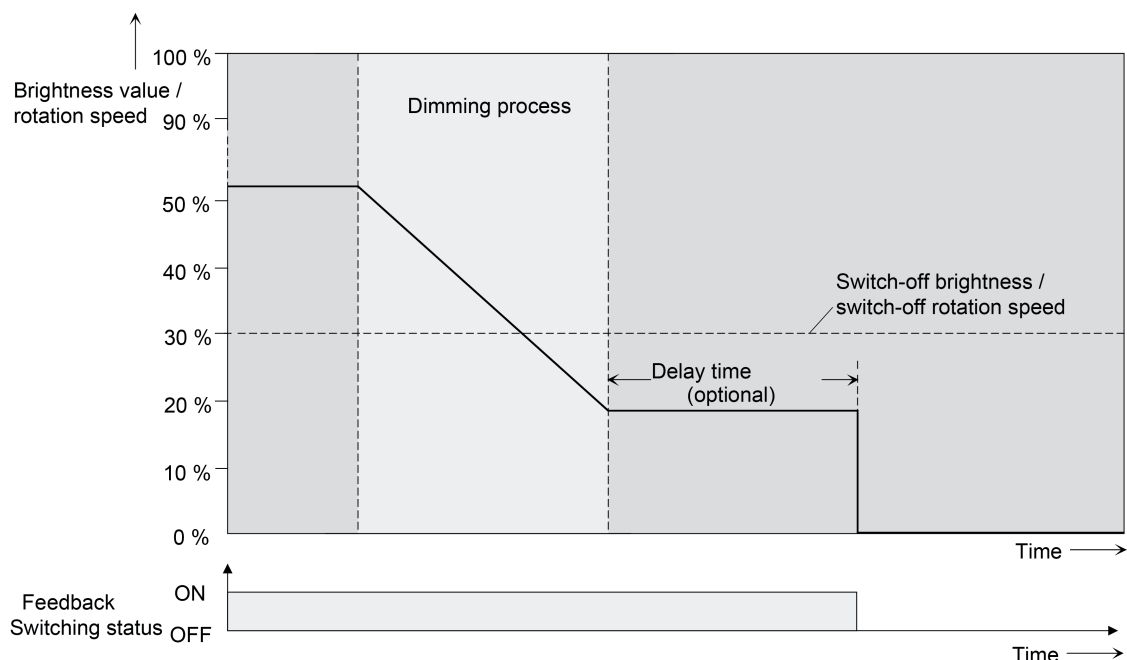

Figure 19: Dimming and switching behaviour of the automatic switch-off function

- i** Switching off always takes place without soft OFF function, i.e. jumping.
- i** The switch-off brightness in the dimmable brightness range can be set between basic and maximum brightness or minimum and maximum brightness. The switch-off function is always active if the switch-off brightness is configured to maximum brightness and the maximum brightness is randomly undershot.
- i** The feedback objects for switching state and brightness value are updated by the automatic switch-off function after switching off.

The automatic switch-off can firstly be activated by a dimming procedure initiated via the 4-bit ("dimming") or 1-byte ("brightness value") communication object. Secondly, the automatic switch-off can also be activated if a dimming channel is switched on (switch-on brightness < switch off brightness) or a brightness is set by programming with the ETS or by a bus voltage failure or by bus / mains voltage return. The automatic switch-on can also be activated during a scene recall.

It should be noted that the disabling function or forced position function overrides the switch-off

function (Figure 20). If the switch-off function is overridden, the actuator terminates the evaluation of the switch-off brightness.

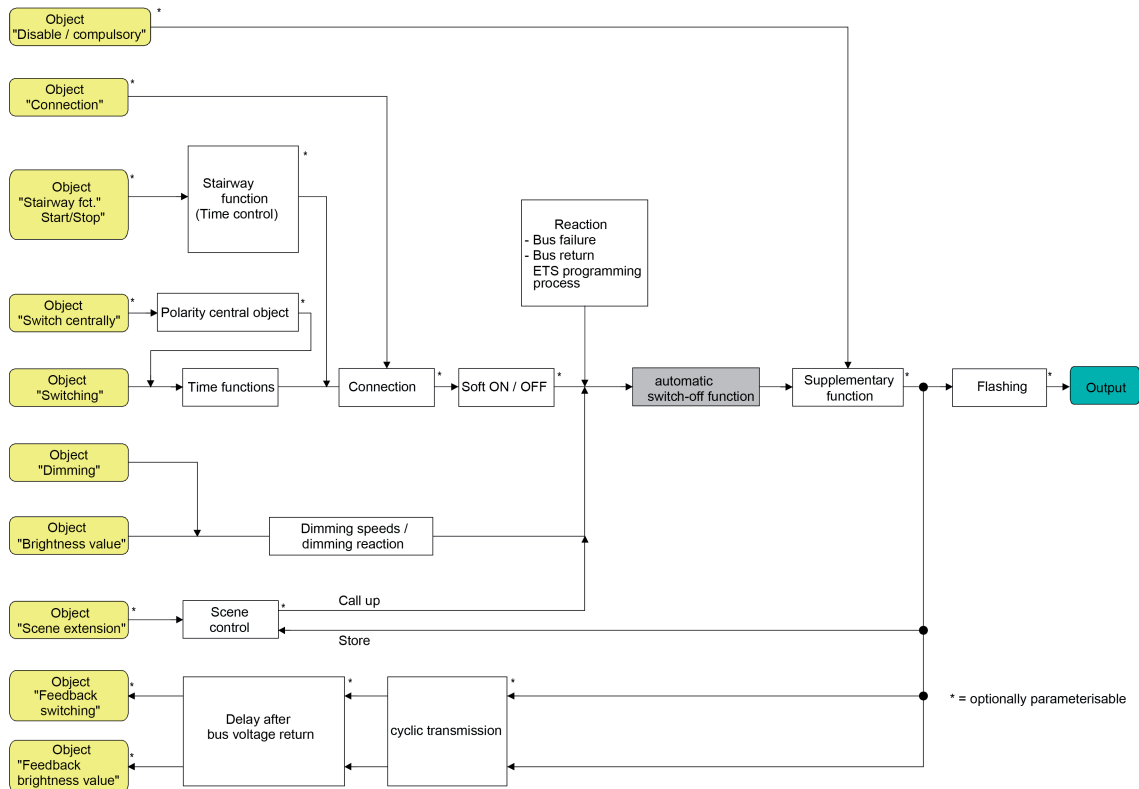

Figure 20: Function diagram of the automatic switch-off function

Enabling automatic switch-off function

The automatic switch-off function can be set separately for each dimming channel in the ETS. The switch-on/switch-off behaviour on the parameter page "Kx - Enabled functions" (x = number of dimming channel 1...4) must be enabled.

- Set the parameter "Automatic switch-off when undershooting a brightness ?" on the parameter page "Kx – Switch-on/switch-off behaviour" to "Yes".

The automatic switch-off function is enabled and activated. Additional parameters become visible.

Setting the switch-off brightness

The switch-off brightness must be defined for the switch-off function. The switch-off function is set separately for each dimming channel in the ETS.

The switch-off function must be enabled in the ETS.

- Set the parameter "Switch off if brightness value is smaller" on parameter page "Kx – Switch-on/switch-off behaviour" to the required brightness value.

Once a dimming procedure causes a value to fall below the parameterized shutoff brightness and once the brightness has been set to constant, the dimming channel concerned switches off or alternatively starts the delay until switching off.

- i** It should be noted that the configured value for the switch-off brightness is greater than any configured minimum brightness and less than the set maximum brightness (minimum brightness < switch-off brightness < maximum brightness)!
- i** Using the staircase function with pre-warning/continuous lighting: The reduced brightness of the pre-warning or continuous lighting does not start the switch-off function after reaching or undershooting the switch-off brightness!

Setting the delay of the switch-off function

A delay can be activated before the switch-off function switches-off automatically after undershooting the switch-off brightness at the end of a dimming procedure. The time for the delay can optionally be enabled separately for each dimming channel.

The switch-off function must be enabled in the ETS.

- Configure the parameter "Delay until switching off" on the parameter page "Kx – Switch-on-/Switch-off behaviour" to the required delay time.

Once a dimming procedure causes a value to fall below the parameterized shutoff brightness and once the brightness has been set to constant, the actuator triggers the delay time. The dimming channel concerned switches off for good once the delay time has elapsed. The delay time can be re-triggered by further dimming procedures.

- i** For the "1-gang" device variant in the "speed controller" operating mode it should be noted that the delay time of the switch-off function is set greater than the "dwell time in cutting-in speed" (parameter page "K1 - General")! Otherwise, after the dwell time elapses immediately after switching off a motor, the switch-on function will have no effect because the dwelling in the cutting-in speed has a higher priority.

4.2.4.2.11 Staircase function / Time dimmer function

The staircase function can be used for implementing time-controlled lighting of a staircase or for function-related applications. The staircase function must be enabled in the ETS on parameter page "Kx - Enabling functions (x = Number of the dimming channel 1...4) in order for the required communication objects and parameters to be visible.

The staircase function is activated via the communication object "staircase function start / stop" and is independent of the "switching" object of a dimming channel (Figure 21). In this way, 'parallel operation' of time and normal control is possible, whereby the command last received is always executed: A telegram to the "switching" object or a scene recall at the time of an active staircase function aborts the staircase time prematurely and presets the switching state according to the received object value (the time delays are also taken into account) or scene value. Likewise, the switching state of the "switching" object can be overridden by a staircase function.

Time-independent continuous light switching can also be implemented in combination with a disabling function because the disabling function has a higher priority and overrides the switching state of the staircase function.

The staircase function can also be extended by means of a supplementary function. At the same time, it is possible activate a time extension. The "time extension" permits retriggering of an activated staircase via the object "Staircase function Start / Stop" n times. Alternatively, the "Time preset via the bus" can be set. With this supplementary function, the configured staircase time can be multiplied by a factor received via the bus, thus it can be adapted dynamically. Furthermore, an extension of the staircase function can be implemented by means of a separate switch-on delay and pre-warning function. During the pre-warning, the brightness of a dimming channel can be reduced. According to DIN 18015-2, the pre-warning should warn persons on the staircase that the light will soon be switched off. As an alternative to the pre-warning at the end of the staircase time, the actuator can activate reduced continuous lighting. In this way, for example, long, dark hallways can have permanent basic lighting.

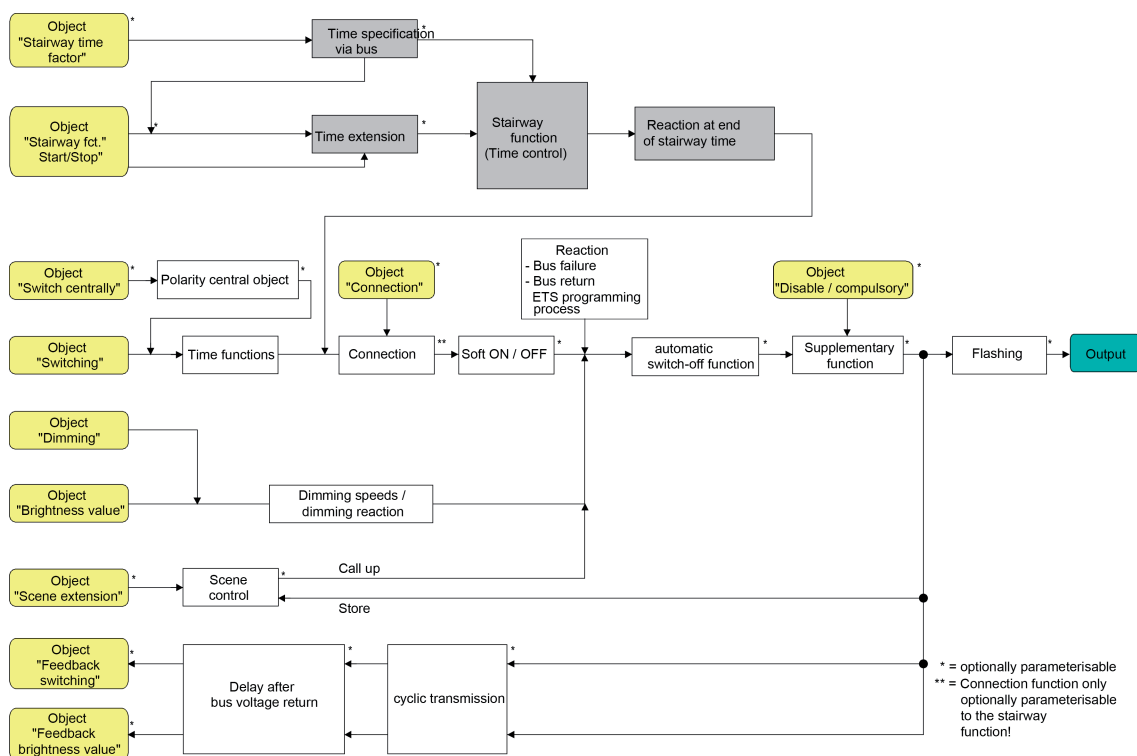

Figure 21: Function diagram of the staircase function

- i** In the "speed controller" operating mode for the "1-gang" device variant the staircase function is described as a time dimmer function. The supplementary function "time extension" is not necessary in the time dimmer function. Additional differences between the "speed controller" operating mode compared to the "lighting control" operating mode can be read in detail in the chapter "Features in the speed controller operating mode" (see page 112).

Specifying switch-on behaviour of the staircase function

An ON telegram to the "staircase function start/stop" object activates the staircase time (T_{EIN}), the duration of which is defined by the "staircase time" parameters. The output switches to switch-on brightness.

At the end of the staircase time, the dimming channel shows the "reaction at the end of the staircase time" configured in the ETS. At the same time, the channel can switch off, optionally activate the pre-warning time ($T_{Vorwarn}$) of the pre-warning function (see page 85-86) or dim to the reduced continuous lighting (application: e.g. long, dark hallways). Taking into account any possible pre-warning function, this gives rise to the example switch-on behaviour of the staircase function (Figure 22).

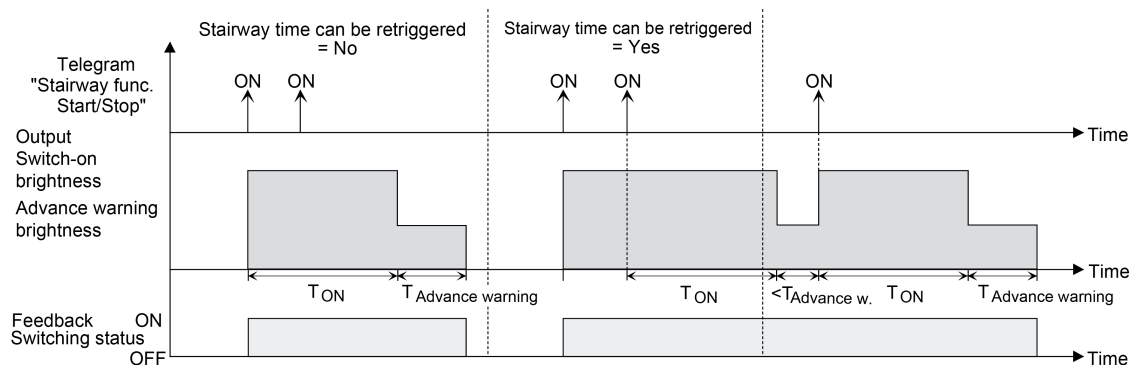

Figure 22: Switch-on behaviour of the staircase function without soft functions

In addition, switching on can be influenced by the soft functions of the actuator. Taking into account any soft ON and soft OFF function, this gives rise to a modified switch-on behaviour of the staircase function (Figure 23).

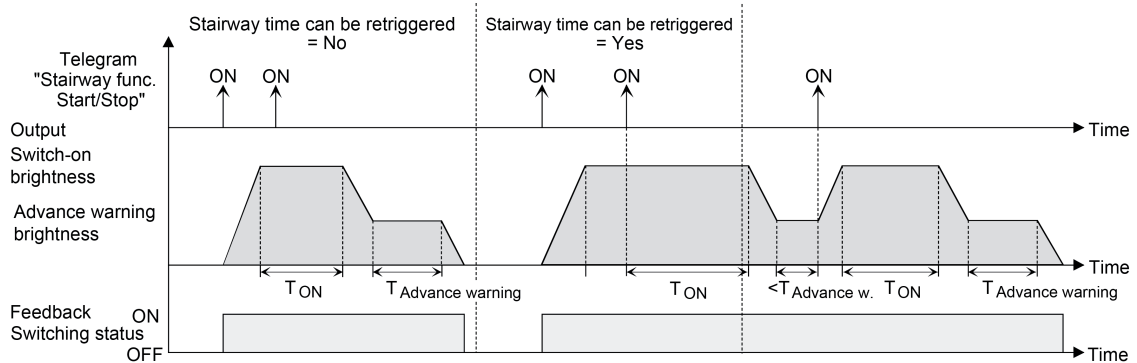

Figure 23: Switch-on behaviour of the staircase function with soft functions (for example with minimum brightness = 0 %)

- Set the parameter "Staircase function ?" on parameter page "Kx - Enabled functions" (x = number of dimming channel 1...4) to "enabled".
The staircase function is enabled. Additional parameters become visible on the parameter page "Kx – Staircase function".
 - In the "staircase time" parameter on parameter page "Kx – Staircase function", configure the necessary switch-on time of the staircase function.
 - Set the parameter "Staircase time retriggerable ?" on the parameter page "Staircase function" to "Yes".
Every ON telegram received during the ON phase of the staircase time retriggeres the staircase time completely.
 - The parameter "Staircase time retriggerable ?" is alternatively preset to "no".
ON telegrams received during the ON phase of the staircase time are rejected. The staircase time is not retriggered.
- i** An ON telegram received during the pre-warning time or during the reduced continuous lighting triggers the staircase time independently of the parameter "Staircase time retriggerable ?" always afterwards.

Specifying switch-off behaviour of the staircase function

In the case of a staircase function, the reaction to an OFF telegram can also be configured on the object "staircase function start/stop". At the end of the staircase time, a dimming channel always shows the "reaction at the end of the staircase time" configured in the ETS, without the receipt of an OFF telegram. At the same time, the channel can switch off, optionally activate the pre-warning time (T_{Vorwarn}) of the pre-warning function (see page 85-86) or dim to the reduced continuous lighting (application: e.g. long, dark hallways).

If, on the other hand, the dimming channel receives an OFF telegram via the object "Staircase function start/stop", the actuator evaluates the parameter "Reaction to an OFF-telegram". In this case, the channel can react immediately to the OFF telegram and end the staircase time prematurely. Alternatively, the OFF telegram can be ignored.

Taking into account any possible pre-warning function, this gives rise to the example switch-off behaviour of the staircase function (Figure 24).

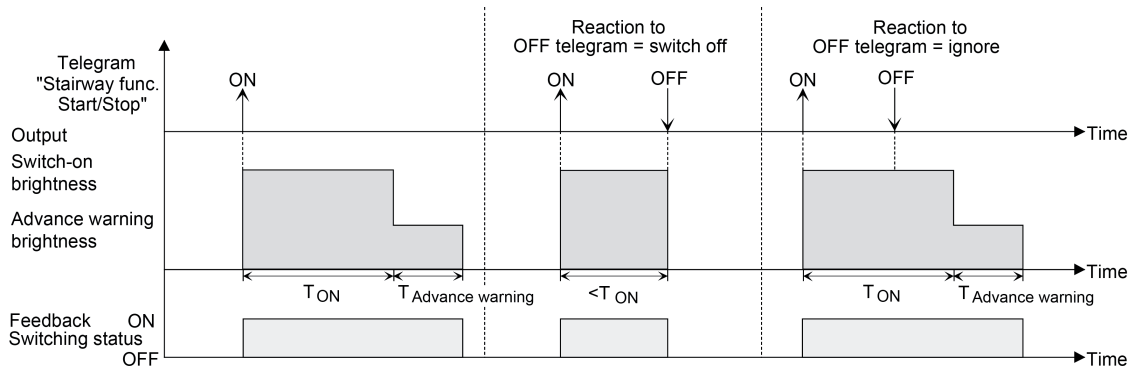

Figure 24: Switch-off behaviour of the staircase function without soft functions

In addition, the switch-off can be influenced by the soft functions of the actuator. Taking into account any soft ON and soft OFF function, this gives rise to a modified switch-off behaviour of the staircase function (Figure 25).

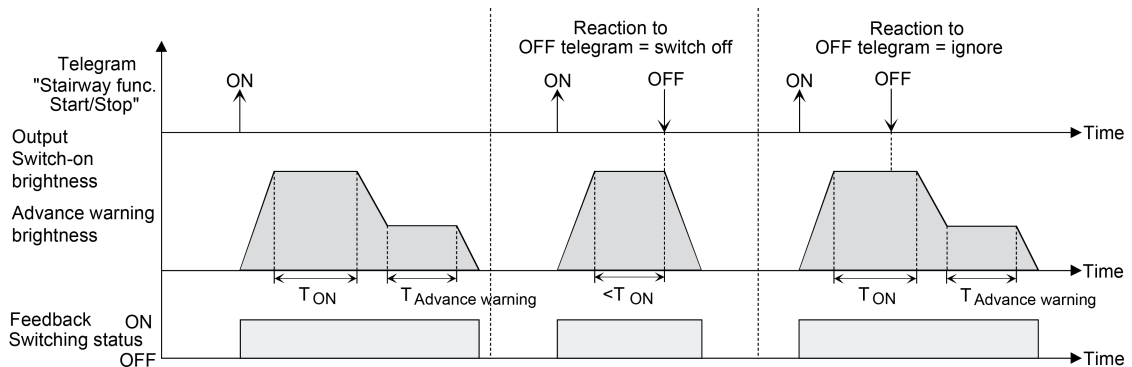

Figure 25: Switch-off behaviour of the staircase function with soft functions
(for example with minimum brightness = 0 %)

The parameter "Reaction to OFF-telegram" on the parameter page "Kx – Staircase function" (x = number of the dimming channel 1...4), defines whether the staircase time (T_{EIN}) of the staircase function can be aborted prematurely.

The staircase function must be enabled in the ETS.

- Set the parameter "Reaction to OFF-telegram" to "switch off".

Once an OFF telegram is received via the object "Staircase function start/stop" during the ON phase of the staircase time, the dimming channel concerned switches off immediately. If the staircase time is stopped prematurely by such a telegram, there is no pre-warning, i.e. the pre-warning time is not started. It is also not dimmed to a reduced continuous lighting. It is also possible to switch off prematurely during a dimming procedure of a soft function or during a pre-warning or reduced continuous lighting.

- Set the parameter "Reaction to OFF-telegram" to "ignore".

OFF telegrams received via the object "staircase function start / stop" during the ON phase of the staircase function are rejected. The staircase time will be executed completely to the end with the configured "behaviour at the end of the staircase time".

Setting the pre-warning function of the staircase function

At the end of the switch-on time of the staircase function, the actuator for the dimming channel concerned shows the "reaction at the end of the staircase time" configured in the ETS. The channel can be set to switch off immediately, alternatively to dim to the reduced continuous lighting (application: e.g. long, dark hallways) or to execute the pre-warning function. If the parameter is configured to "activate pre-warning time", the pre-warning time (T_{Vorwarn}) and pre-warning brightness can be configured in the ETS.

The pre-warning should, according to DIN 18015-2, warn persons still on the staircase that the light will soon be switched off. As a pre-warning, a dimming channel can be set to a pre-warning brightness before the channel switches off permanently. The pre-warning brightness is normally reduced in the brightness value compared to the switch-on brightness.

The pre-warning time is added to the staircase time (T_{EIN}) (Figure 26). The pre-warning time influences the values of the feedback objects so that the switching state "OFF" and the value "0" is first tracked after the pre-warning time in the feedback objects has elapsed.

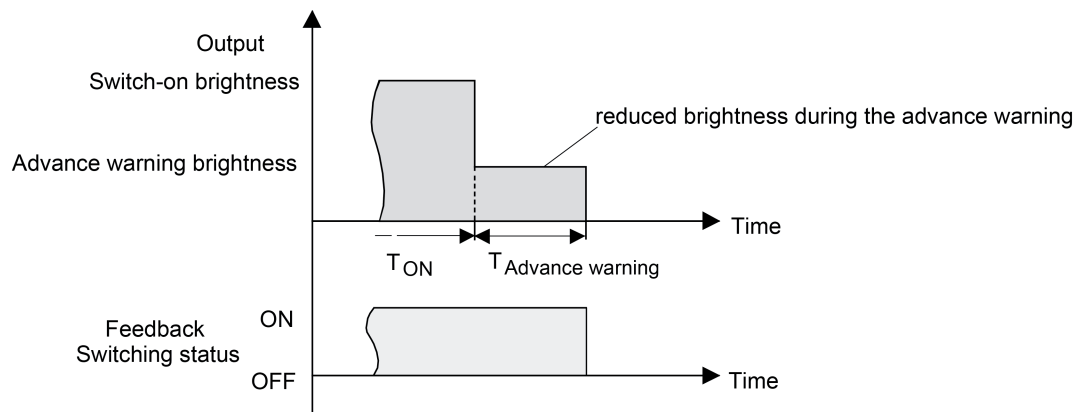

Figure 26: The pre-warning function of the staircase function without soft OFF function

Additionally, the pre-warning function can also be extended by the soft OFF function. Taking into account any soft OFF function, this gives rise to a modified switch-off behaviour of the staircase function after the pre-warning has elapsed (Figure 27).

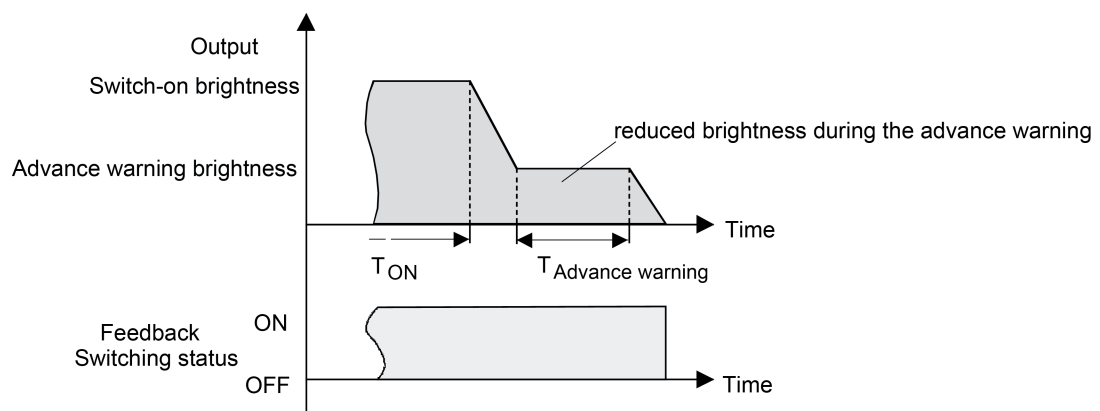

Figure 27: The pre-warning function of the staircase function with soft OFF function (for example with minimum brightness = 0 %)

- i** The pre-warning brightness does not necessarily have to be less than the switch-on brightness. The pre-warning brightness can always be configured to values between basic/minimum brightness and maximum brightness.

The staircase function must be enabled.

- Set the parameter "Reaction at the end of the staircase time" on the parameter page "Kx – Staircase function" (x = number of the dimming channel 1...4) to "activate pre-warning time".
The pre-warning function is enabled. The desired pre-warning time (T_{Vorwarn}) can be preset.
- Configure the "pre-warning time".
- Set the parameter "Reduced brightness during the pre-warning time (1...100 %)" to the desired brightness value.
During the pre-warning time, the dimming channel is set to the configured brightness value.
- i** The configured value for the reduced brightness must be greater than or equal to the minimum brightness (if configured) or less than or equal to the maximum brightness!
- i** An ON telegram to the object "Staircase function start/stop" while a pre-warning function is still in progress stops the pre-warning time and always starts (independently of the parameter "Staircase time retriggerable ?") the staircase time anew. Even during the pre-warning time, the parameter "reaction to OFF telegram" is evaluated so that a pre-warning in progress can be terminated early by switching off.
- i** Using the automatic switch-off function: The reduced brightness of the pre-warning does not start the switch-off function after reaching or undershooting the switch-off brightness!

Setting continuous lighting of the staircase function

At the end of the switch-on time of the staircase function, the actuator for the dimming channel concerned shows the "reaction at the end of the staircase time" configured in the ETS. The channel can be set to switch off immediately, alternatively to execute a pre-warning function, or to dim to reduced continuous lighting. The reduction of the lighting to continuous lighting after the staircase time has elapsed is appropriate, for example, if a certain degree of artificial light should be switched on permanently in long, dark hallways. Switching to switch-on brightness by activating the staircase function normally takes place by additional presence detectors or motion detectors when people are present in the hallway.

If the parameter "Reaction at the end of the staircase time" is configured to "activate reduced continuous lighting", the brightness for the continuous lighting can be configured in the ETS. The continuous brightness is normally reduced in the brightness value compared to the switch-on brightness.

The continuous lighting remains permanently active after the staircase time has elapsed. Only when an ON telegram is received again via the object "Staircase function start/stop" does the actuator switch back to the switch-on brightness and start counting the staircase time again. The receipt of an OFF telegram via the object "staircase function start/stop" only switches the continuous lighting off if the parameter "Reaction to OFF-telegram" is configured to "switch off".

- i** A dimming channel can always be switched on and off via the "switching" object independently of the staircase function. Consequently, continuous lighting will also be overridden if telegrams arrive on the actuator via the "switching" object.
If permanent continuous lighting is desired, which cannot be influenced by the "switching" object nor by the object of the staircase function, the disabling function of the actuator should be used.

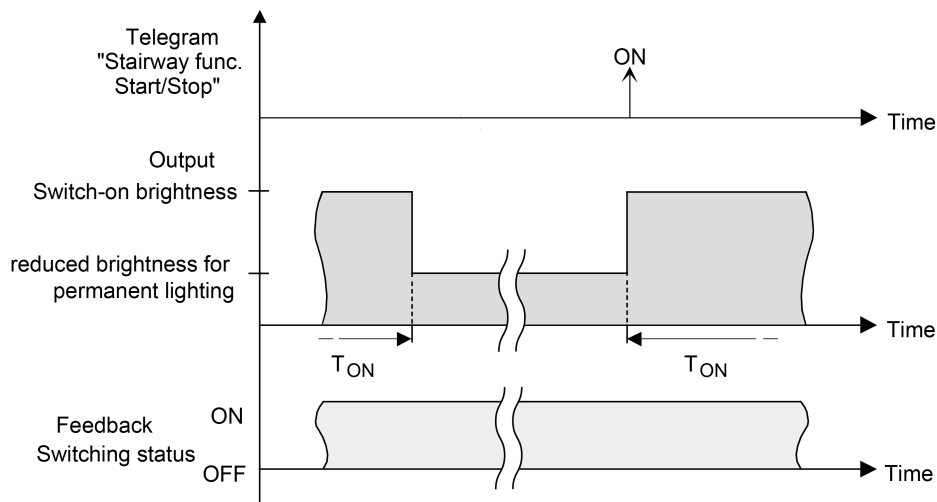

Figure 28: The continuous lighting of the staircase function without soft functions

Additionally, the continuous lighting can also be extended by the soft function. Taking into account any soft ON and soft function, this gives rise to modified continuous lighting behaviour of the staircase function (Figure 27).

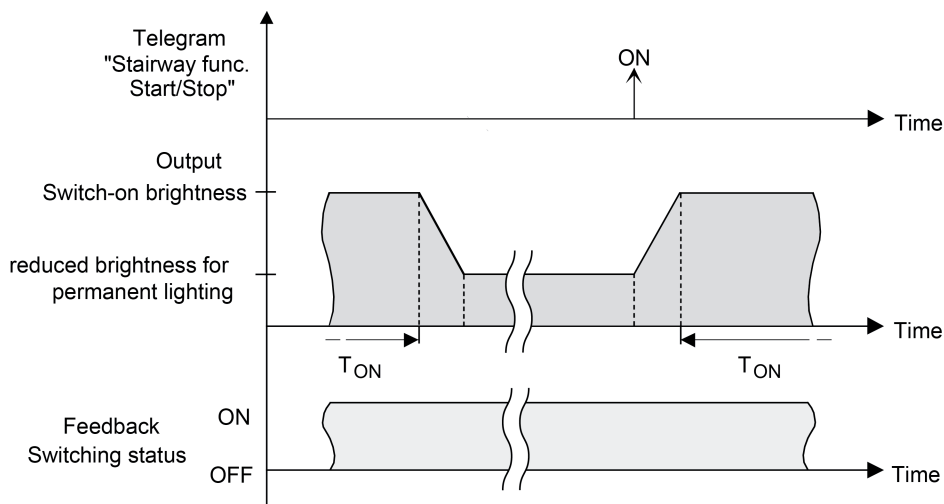

Figure 29: The continuous lighting of the staircase function with soft OFF functions

- i** The brightness of the continuous lighting does not necessarily have to be less than the switch-on brightness. The brightness of the continuous lighting can always be configured to values between basic/minimum brightness and maximum brightness.

The staircase function must be enabled.

- Set the parameter "Reaction at the end of the staircase time" on the parameter page "Kx – Staircase function" (x = number of the dimming channel 1...4) to "activate reduced continuous lighting".

The continuous lighting is enabled. The "reduced brightness for continuous lighting (1...100 %)" can be set to the desired brightness value.

- i** The configured value for the reduced brightness must be greater than or equal to the minimum brightness (if configured) or less than or equal to the maximum brightness!
- i** An ON telegram to the object "Staircase function start/stop" always starts (independently of the parameter "Staircase time retriggerable ?") the staircase time anew. Even during activated continuous lighting, the parameter "Reaction to OFF telegram" is evaluated so that continuous lighting can be switched off.
- i** Using the automatic switch-off function: The reduced brightness of the continuous lighting does not start the switch-off function after reaching or undershooting the switch-off brightness!

Setting supplementary function of the staircase function – time extension

With the time extension function, the staircase time can be retriggered several times (i.e. extended) via the "Staircase function start/stop" object. The duration of the extension is predefined by several operations at the control section (several ON telegrams in succession). The configured staircase time can be extended in this way by the configured factor (a maximum of 5-fold). The time is then always extended automatically at the end of a single staircase time (T_{EIN}).

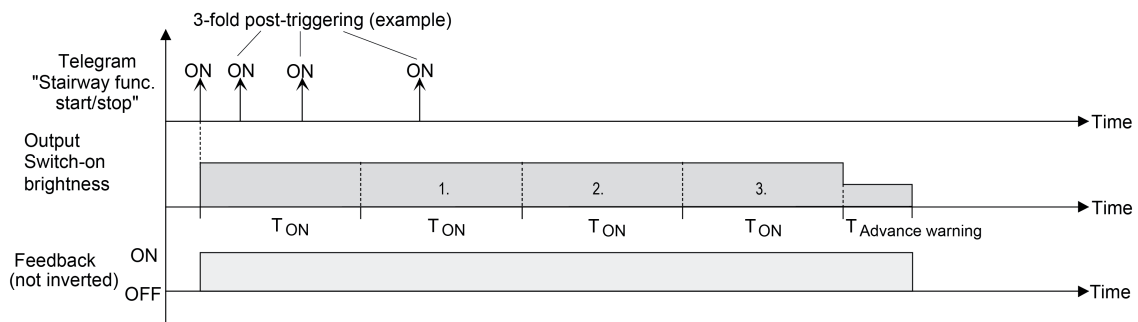

Figure 30: Time extension of the staircase function

With this function, the lighting time in a staircase can be extended (e.g. by a person after shopping) by a defined length without having to retrigger the lighting every time the lighting shuts off automatically.

The staircase function must have been enabled on parameter page "Kx – Enabled functions."

- Set the parameter "Supplementary function for staircase function" on the parameter page "Kx – Staircase function" to "time extension" and set the maximum desired factor on the parameter "maximum time extension".

The staircase time is retriggered each time an ON telegram is received on the "staircase time start/stop" object after the staircase time has elapsed, depending on the number of telegrams received, but only as often as pre-defined by the configured factor. For example, the "3-fold time" setting means that after the started staircase time has elapsed, it can be retriggered automatically a maximum of three additional times. The time is therefore extended a maximum of four fold (Figure 30).

- i** A time extension can be triggered during the entire staircase time (T_{EIN}). There is no time limit between two telegrams for the time extension. Telegrams for the time extension are only evaluated during the staircase time. An ON telegram during the pre-warning function or continuous lighting triggers the staircase time as a restart, which means that a new time extension is possible.
- i** If a time extension was configured as a supplementary function, the parameter "Staircase time retriggerable ?" is preset to "No" because the retriggering takes place by the time extension.

- i** The time extension cannot be configured in the "speed controller" operating mode for the "1-gang" device variant.

Setting supplementary function of the staircase function – time preset via the bus

With the time preset via the bus, the configured staircase time can be multiplied by an 8-bit factor received via the bus, thus it can be adapted dynamically. With this setting, the factor is derived from the object "staircase time factor". The possible factor value for setting the staircase time is between 1...255.

The entire staircase time arises as a product from factor (object value) and the configured staircase time as a basis as follows...

Staircase time = (staircase time object value) x (staircase time parameter)

Example:

Object value "staircase time factor" = 5; parameter "staircase value" = 10s.

-> set staircase time = 5 x 10s = 50 s

Alternatively, the staircase function parameter can define whether the receipt of a new factor also starts the staircase time of the staircase function at the same time. In this case, the object "Staircase function start/stop" is not necessary and the received factor value determines the starting and stopping.

The staircase function must have been enabled on parameter page "Kx – Enabled functions.

- Set "supplementary function for staircase function" on the parameter page "Kx – Staircase function" to "time preset via the bus" and set the parameter "staircase function activatable via 'staircase time' object ?" to "No".

The staircase time can be adapted dynamically by the object "staircase time factor". A value "0" is interpreted as value "1". The staircase function is started and stopped exclusively via the "staircase function start / stop" object.

- Set "supplementary function for staircase function" on the parameter page "Kx – Staircase function" to "time preset via the bus" and set the parameter "staircase function activatable via 'staircase time' object ?" to "Yes".

The staircase time can be adapted dynamically by the "staircase time factor" object. In addition, the staircase function is started with the new staircase time (the "staircase function start / stop" is not necessary) after receiving a new factor. A factor value "0" is interpreted as an OFF telegram, whereby in this case, the configured reaction to an OFF telegram is evaluated, too.

A larger staircase with several floors is an example as an application for the time preset via the bus with automatic starting of the staircase time. On each floor there is a pushbutton that transmits a factor value to the staircase function. The higher the floor, the greater the factor value transmitted so that the lighting stays switched on longer if the passing through the staircase needs more time. When a person enters a staircase and a pushbutton is pressed, the staircase time is now adjusted dynamically to the staircase time and switches on the lighting at the same time, too.

- i** Setting "Staircase function activatable via"Staircase time" object ?" = "Yes":
A factor > 0 received during a warning time triggers the staircase time independently of the parameter "staircase time retriggerable ?" always afterwards.
- i** After a reset (bus voltage return or ETS programming) the "staircase time factor" object is always initialised with "1". The staircase function is not started automatically solely as the result of this, however (see page 89-90).
- i** The two supplementary functions "time extension" and "time preset via the bus" can only be configured alternatively.

Behaviour of the staircase function after bus or mains voltage return presetting

The staircase function can be started automatically after bus or mains voltage return.

The staircase function must have been enabled on parameter page "Kx – Enabled functions.

- Set the parameter "Behaviour after bus or mains voltage return" on the parameter page "Kx – General" to "activate staircase function".

i In the "speed controller" operating mode for the "1-gang" device variant, the parameter setting is called "activate time dimmer function".

Immediately after bus or mains voltage return, the staircase time of the staircase function is started.

i The parameter "behaviour after bus or mains voltage return" will always be executed on return of bus voltage only if the mains voltage (without bus) is switched on. If the mains voltage is switched on when the bus voltage is present, the actuator does not execute any particular reaction.

i With this setting you should note that the staircase function is also enabled and programmed. When the staircase function is not enabled, there is no reaction after bus/mains voltage return with this setting.

i The configured behaviour will only be executed, if no forced position on bus voltage return is activated.

4.2.4.2.12 Light scene function

Up to 8 scenes can be programmed and scene values stored separately in the actuator for each dimming channel. The scene values are recalled or stored via a separate scene extension object by means of extension telegrams. The datapoint type of the extension object permits addressing a maximum of 64 scenes. This means that, in the configuration of a scene, it is possible to specify which scene number (1...64) contacts the internal scene (1...8).

The scene function must be enabled on parameter page "Kx - Enabling functions" for each dimming channel in order for the required communication objects and parameters (on the parameter page "Kx - Scenes") to be visible.

The scene function can be combined together with other functions of a dimming channel (cf. Fig 20), whereby the last received or preset state is always executed:

Telegrams to the "switching", "dimming" or "brightness value" objects, a scene recall or scene storage telegram at the time of an active staircase function aborts the staircase time prematurely and presets the brightness state according to the received object value (time delays are also taken into account) or scene value. Likewise, the brightness state of the dimming channel, which was preset by the "switching", "dimming" or "brightness value" objects or by a scene recall, can be overridden by a staircase function.

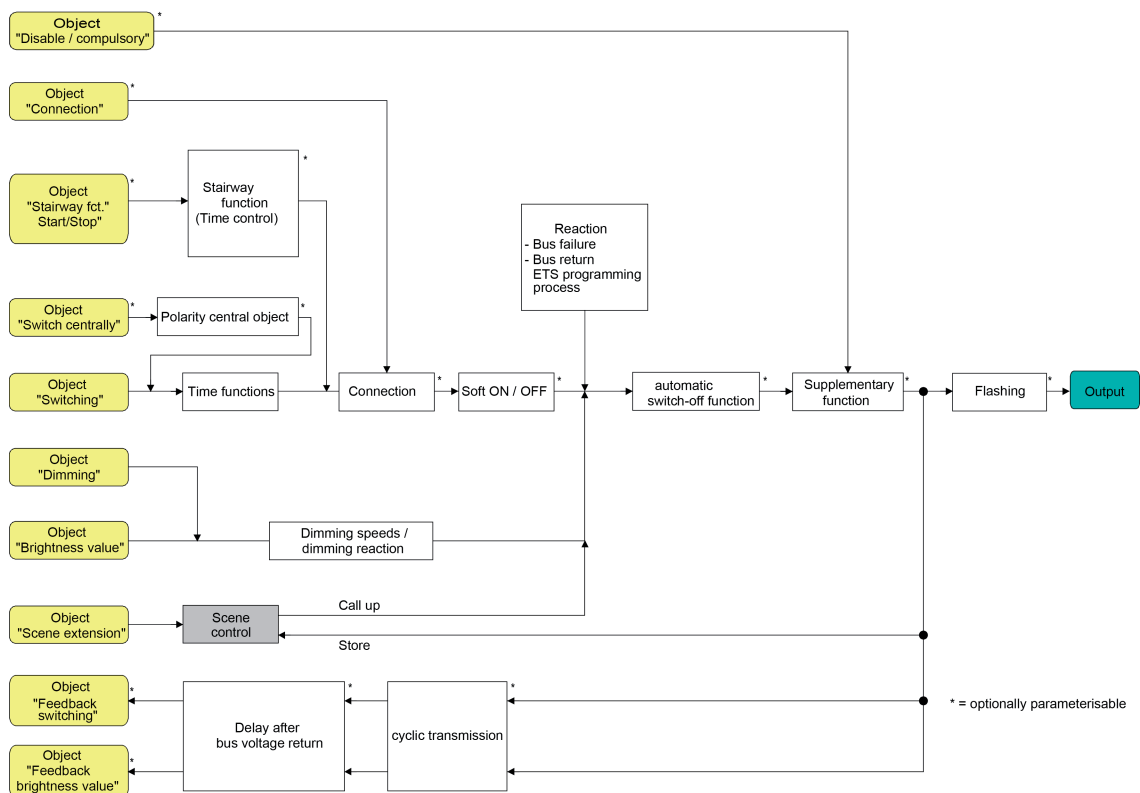

Figure 31: Function diagram of the scene function

- i** In the "speed controller" operating mode for the "1-gang" device variant - similar to the description of the brightness values for lighting control in this chapter - the speed values can be configured in the ETS. The differences between the "speed controller" operating mode compared to the "lighting control" operating mode can be read in detail in the chapter "Features in the speed controller operating mode" (see page 112).

Presetting a scene recall delay for the scene function

Each scene recall of a dimming channel can optionally also be delayed. With this feature, dynamic scene sequences can be configured if several scene output channels are combined with cyclical scene telegrams.

The scene function must be enabled on parameter page "Kx – Enabled functions (x = number of the dimming channel 1...4).

- Set the parameter "Delay scene recall?" to "Yes".
The delay time is now activated and can be configured separately. The delay only influences the scene recall of the dimming channel. The delay time is started on arrival of a recall telegram. The corresponding scene will be recalled and the brightness value set on the dimmer output only after this time has elapsed.
- ❗ Each scene recall telegram restarts the delay time and retriggers it. If a new scene recall telegram is received while a delay is active (scene recall not yet executed), the old (and not yet recalled scene) will be rejected and only the scene last received executed.
- ❗ The scene recall delay has no influence on the storage of scene values. A scene storage telegram within a scene recall delay terminates the delay and thus the scene recall.

Setting behaviour when recalling a scene

In the scene configuration of a dimming channel, it is possible to define whether the light intensity instantly jumps or dims to the scene brightness. When dimming, it can also be predefined whether the dimming procedure should be executed normally by dimming increments or by fading. A scene recall can therefore be executed independent of the set dimming behaviour and dimming characteristic of an output.

The behaviour during a scene recall can be configured separately for each scene.

The scene function must be enabled on parameter page "Kx – Enabled functions (x = number of the dimming channel 1...4).

- Set the parameter "Behaviour when recalling a scene" on parameter page "Kx – Scenes" to "jump to brightness value".
The scene brightness values are instantly jumped to during a recall.
- Set the parameter "Behaviour when recalling a scene" on parameter page "Kx – Scenes" to "dim to brightness value via dimming increment time". At the same time, define the required "dimming increment time (0...255 ms)" to dim to the scene brightness value.
The scene brightness values of the scene concerned are dimmed to during a recall. The time in the parameter selection defines the duration of the dimming procedure between 2 of 255 dimming increments.
- Set the parameter "Behaviour when recalling a scene" on parameter page "Kx – Scenes" to "dim to brightness value via fading". At the same time, define the "fading time (0...240 ms)" required to dim to the scene brightness value.
The scene brightness values of the scene concerned are dimmed to during a recall. The dim fading is now activated. The time in the parameter selection defines the duration of the dimming procedure required to reach the scene brightness value. The brightness value of a dimming channel at which the dimming starts and the configured dimming characteristic have no significance. Thus, the dimming procedure in case of a scene recall always requires the exact predefined time.
- ❗ The parameter setting "dim via fading" is not available in the "speed controller" operating mode for the "1-gang" device variant.

Presetting the ETS download behaviour for the scene function

During storage of a scene, the scene values are stored permanently in the device (see page 93-94). To prevent the stored values from being replaced during ETS programming of the

application or of the parameters by the originally programmed scene brightness values, the actuator can inhibit overwriting of the scene values. As an alternative, the original values can be reloaded into the device during each programming run of the ETS.

The scene function must be enabled on parameter page "Kx – Enabled functions (x = number of the dimming channel 1...4).

- Set the parameter "Overwrite the values stored in the device during ETS download ?" to "Yes".

During each ETS programming of the application or of the parameters, the scene values parameterized in the ETS for the dimming channel concerned will be programmed into the actuator. Scene values stored in the device by means of a storage function will be overwritten, if any.

- Set the parameter "Overwrite the values stored in the device during ETS download ?" to "No".

Scene values stored in the device with a storage function will be maintained. If no scene values have been stored, the brightness values last programmed in the ETS remain valid.

- i** When the actuator is put into operation for the first time, this parameter should be set to "yes" so that the dimming channel is initialized with valid scene values.

Presetting scene numbers and scene brightness values for scene function

The datapoint type of the scene extension object permits addressing of up to 64 scenes max. For this reason, the scene number (1...64) with which the scene is addressed, i.e. recalled or stored, must be determined for each internal scene (1...8) of the dimming channel. Moreover, the brightness value to be set for the dimming output in case of a scene recall must be specified as well.

The scene function must be enabled on parameter page "Kx – Enabled functions (x = number of the dimming channel 1...4).

- Set the parameter "Scene x activatable by scene number" (x = number of the scene (1...8)) on parameter page "Kx – Scenes" for each scene to the numbers with which the scenes are to be addressed.

A scene can be addressed with the configured scene number. A setting of "0" deactivates the corresponding scene so that neither recalling nor storage is possible.

- i** If the same scene number is parameterized for several scenes, only the scene with the lowest internal scene number (1...8) will be addressed. The other internal scenes will be ignored in this case.

- Set the parameter "brightness value for scene x" (x = number of the scene (1...8)) on parameter page "Kx – Scenes" for each scene to the desired brightness value

During a scene recall, the parameterized brightness value is recalled and set on the dimming channel.

- i** The parameterized brightness value is adopted in the actuator during programming with the ETS only if the parameter "Overwrite values stored in the device during ETS download ?" is set to "Yes".

- i** It should be noted that the configured value for the scene brightness is greater than a configured minimum brightness (if applicable) and less than the set maximum brightness!

Presetting the storage behaviour for the scene function

The scene brightness value preset according to the function diagram can be stored internally via the extension object on reception of a scene storage telegram – also during a dimming procedure. In this case, the brightness value can be influenced before the storage by all functions of the dimming channel provided the individual functions have been enabled (e.g. also the disabling function, forced-control position function, manual control, etc.).

The scene function must be enabled on parameter page "Kx – Enabled functions (x = number of the dimming channel 1...4).

- Set the parameter "Storage function for scene x" (x = number of the scene (1...8)) on parameter page "Kx – Scenes" for each scene to "Yes".

The storage function is activated for the scene in question. On reception of a storage telegram via the "Scene extension" object, the current brightness value will be internally stored.

- Set the parameter "Storage function for scene x" (x = number of the scene (1...8)) on parameter page "Kx – Scenes" for each scene to "No".

The storage function is deactivated for the scene in question. A storage telegram received via the "scene extension" object will be rejected.

4.2.4.2.13 Operating hours counter

The operating hours counter determines the switch-on time of a dimming channel. A channel is actively on for the operating hours counter if the brightness value is greater than "0", i.e. when current is flowing to the load.

The operating hours counter adds up the determined switch-on time accurately to the minute for switched-on dimming channels in full hours respectively (Figure 32). The totalled operating hours are added in a 2-byte counter and stored permanently in the device. The current counter status can be transmitted cyclically to the bus by the "value operating hours counter" communication object or when there is a change in an interval value.

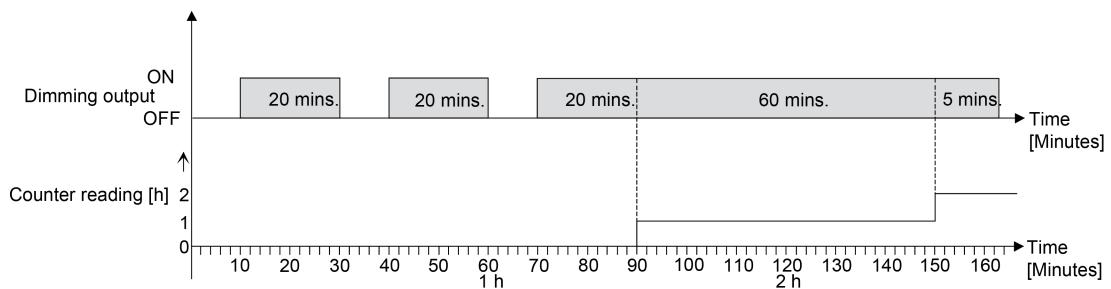

Figure 32: Function of the operating hours counter (using the example of an up-counter)

In the as-delivered state, the operating hour values of all dimming channels is "0". If the operating hours counter is not enabled in the configuration of a dimming channel, no operating hours will be counted for the channel concerned. Once the operating hours counter is enabled, however, the operating hours will be determined and added up by the ETS immediately after commissioning the actuator.

If the operating hours counter is subsequently disabled again in the parameters and the actuator is programmed with this disabling function, all operating hours previously counted for the dimming channel concerned will be deleted. When enabled again, the counter status of the operating hours counter is always on "0".

The operating hours values (full hours) stored in the device will not be lost in case of a bus voltage failure or by ETS programming. Any summed up operating minutes (full hour not yet reached) will be rejected in this case, however.

After bus voltage return or after an ETS download, the actuator passively updates the "value operating hours counter" communication object in each dimming channel. The object value can be read out if the read-flag is set. The object value, depending on the configuration for the automatic transmission, is actively transmitted if necessary to the bus once the parameterized transmit delay has elapsed after bus voltage return (see page 98).

The operating hours counter detects any operation of the dimming channels by the manual operation, which means that switching on a channel also activates the counting of operating hours and the manual switch-off interrupts a counting operation.

No operating hours are counted if the mains voltage supply of the individual load outputs is not switched on.

- i If the mains voltage is not switched on (bus voltage switched off / building site operation), summed-up operating hours will not be stored in the event of a mains voltage failure!

Activating the operating hours counter

- Set the parameter "enabling functions" on parameter page "Kx - Operating hours counter" to "enabled".

The operating hours counter is activated.

Deactivating the operating hours counter

- Set the parameter "enabling functions" on parameter page "Kx - Operating hours counter" to "disabled".

The operating hours counter is deactivated.

- i** Disabling of the operating hours counter and subsequent programming with the ETS resets the counter status to "0".

Setting type of counter of the operating hours counter

The operating hours counter can optionally be configured as an up-counter or down-counter. Depending on this type of counter, a limit or start value can be set optionally, whereby, for example, the operating time of a lamp can be monitored by restricting the counter range.

Up-counter:

After activating the operating hours counter by enabling in the ETS or by restarting, the operating hours are counted starting at "0". A maximum of 65535 hours can be counted, after that the counter stops and signals a counter operation via the "Operating hours count. elapsed" object.

A limiting value can be set optionally in the ETS or can be predefined via the communication object "Op. hours counter limit value". In this case, the counter operation is signalled to the bus via the "Op. hours counter elapsed" object if the limiting value is reached, but the counter continues counting - if it is not restarted - up to the maximum value 65535 and then stops. Only a restart initiates a new counting operation.

Down-counter:

After enabling the operating hours counter in the ETS, the counter status is on "0" and the actuator signals a counter operation for the dimming channel concerned after the programming operation or after bus voltage return via the "Op. hours counter elapsed" object. Only after a restart is the down-counter set to the maximum value 65535 the counting operation started. A start value can be set optionally in the ETS or can be predefined via the communication object "Op. hours counter start value". If a start value is set, the down-counter is initialised with this value instead of the maximum value after a restart. The counter then counts the start value downwards by the hour. When the down-counter reaches the value "0", the counter operation is signalled to the bus via the "Op. hours counter elapsed" and the counting is stopped. Only a restart initiates a new counting operation.

The operating hours counter must have been enabled on parameter page "Kx – Enabled functions (x = number of the dimming channel 1...4).

- Set the parameter "Type of counter" on parameter page "Kx - Operating hours counter" to "up-counter". Set the parameter "Limit value preset ?" to "yes, as parameter" or "yes, as received via object" if it is necessary to monitor the limiting value. Otherwise, reset the parameter to "no". In the "yes, as specified in parameter" setting, specify the required limit value (1...65535 h).

The counter counts the operating hours forwards starting from "0". If the monitoring of the limiting value is activated, the actuator transmits a "1"-telegram via the object "Operating hours count. elapsed" for the dimming channel concerned once the predefined limiting value is reached. Otherwise, the counter operation is first transmitted when the maximum value 65535 is reached.

- Set the parameter "Type of counter" on parameter page "Kx - Operating hours counter" to "down-counter". Set the parameter "start value preset ?" to "yes, as parameter" or "yes, as received via object" if a start value preset is necessary. Otherwise, reset the parameter to "no". In the "yes, as specified in parameter" setting, specify the required start value (1...65535 h).

The counter counts the operating hours down to "0" after a restart. With a start value preset, the start value is counted down, otherwise the counting operation starts at the maximum value 65535. The actuator transmits a "1"-telegram via the object "Operating hours count. elapsed" for the dimming channel concerned once the value "0" is reached.

- i** The value of the communication object "Op. hours counter elapsed" is stored permanently. The object is initialised immediately with the value that was saved before bus voltage return or ETS programming. If an operating hours counter is in this case identified as elapsed, i.e. if the object value is a "1", an additional telegram will be actively transmitted to the bus as soon as the parameterized transmit delay has elapsed after bus voltage return. If the counter has not yet elapsed (object value "0"), no telegram is transmitted on return of bus/mains voltage or after an ETS programming operation.
- i** With a limiting or start value preset via object: The values received via the object are first validly accepted and permanently saved internally after a restart of the operating hours counter. The object is initialised immediately with the value that was last saved before bus voltage return or ETS programming. The values received will be lost in the case of a bus voltage failure or by an ETS download if no counter restart was executed before. For this reason, when specifying a new start or limiting value it is advisable to always execute a counter restart afterwards as well.
A standard value of 65535 is predefined provided that no limiting value or start value has been received yet via the object. The values received and stored via the object are reset to the standard value if the operating hours counter is disabled in the parameters of the ETS and a ETS download is being performed.
- i** With a limiting or start value predefined via object: If the start or limiting value is predefined with "0", the actuator will ignore a counter restart to avoid an undesired reset (e.g. in site operation -> hours already counted by manual operation).
- i** If the counter direction of an operating hours counter is reversed by reconfiguration in the ETS, a restart of the counter should always be performed after programming the actuator so that the counter is reinitialised.

Restarting the operating hours counter

The counter status of the operating hours can be reset at any time by the communication object "Restart operating hours counter". The polarity of the restart telegram is predefined: "1" = restart / "0" = no reaction.

- Characterise the communication object "restart operating hours counter" with "1".
In the up-counter the counter is initialised with the value "0" after a restart and in the down-counter initialised with the start value. If no start value was configured or predefined by the object, the start value is preset to 65535.
During every counter restart, the initialised counter status is transmitted actively to the bus. During every counter restart, the initialised counter status is transmitted actively to the bus. After a restart, the signal of a counter operation is also reset. At the same time, a "0" telegram is transmitted to the bus via the object "Operating hours count. elapsed". In addition, the limiting or start value is initialised.
- i** If a new limiting or start value was predefined via the communication object, a counter restart should always be performed afterwards, too. Otherwise, the values received will be lost in the case of a bus voltage failure or by an ETS download.
- i** If a start or limiting value is predefined with "0", there are different behaviours after a restart depending on the principle of the value definition...
Preset as parameter:
The counter elapses immediately after a counter restart.
Preset via object:
A counter restart will be ignored to avoid an undesired reset (e.g. after installation of the devices with hours already being counted by manual operation). A limiting or start value greater than "0" must be predefined in order to perform the restart.

Transmission behaviour of the operating hours counter

The current value of the operating hours counter is always tracked in the communication object "value operating hours counter". After bus voltage return or after an ETS download, the actuator passively updates the "Value operating hours counter" communication object in each dimming channel. The object value can be read out if the read-flag is set.

In addition, the transmission behaviour of this communication object can be set.

The operating hours counter must have been enabled on parameter page "Kx – Enabled functions (x = number of the dimming channel 1...4).

- Set the parameter "Automatic transmission of counting value" on parameter page "Kx - Operating hours counter" to "after change by interval value". Set the "Counting value interval (1...65535 h)" to the desired value.

The counter status is transmitted to the bus as soon as it changes by the predefined counting value interval. After bus voltage return or after programming in the ETS, the object value is transmitted automatically after "Delay after bus voltage return" has elapsed if the current counter status or a multiple of this corresponds to the counting value interval. A counter status "0" is always transmitted in this case.

- Set the parameter "Automatic transmission of counting value" on parameter page "Kx - Operating hours counter" to "cyclical".

The counter value is transmitted cyclically. The cycle time is defined independent of the channel on the parameter page "Times". After bus voltage return or ETS programming, the counter status is transmitted to the bus after the configured cycle time has elapsed.

4.2.4.2.14 Supplementary function

Supplementary functions can be enabled for each dimming channel. As a supplementary function, a disabling or alternatively a forced position function can be configured. In this respect, only one of these functions can be enabled for one channel. Additionally, a logic operation function can be parameterized.

The supplementary functions are enabled on parameter page "Kx – Supplementary functions" (x = number of dimming channels 1...4).

- i** In the "speed controller" operating mode for the "1-gang" device variant - similar to the description of the brightness values for lighting control in this chapter - the speed values can be configured in the ETS. The differences between the "speed controller" operating mode compared to the "lighting control" operating mode can be read in detail in the chapter "Features in the speed controller operating mode" (see page 112).

Setting disabling function as supplementary function

During an active disabling function, the KNX bus control of the dimming function concerned is overridden and locked (Figure 33). Continuous light switching, for example, can also be overridden.

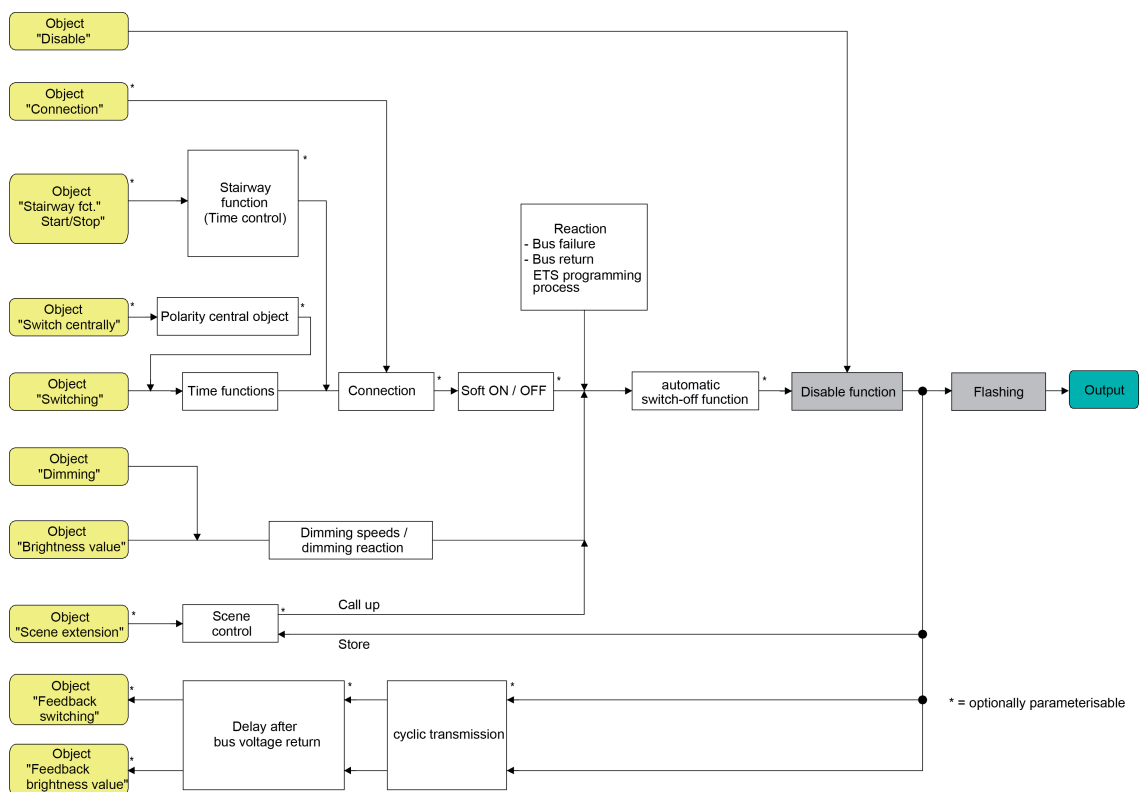

Figure 33: Function diagram of the disabling function

- On the parameter page "Kx - supplementary functions", set the parameter "type of supplementary function" to "disabling function".
The disabling function is enabled. The communication object "Disable" and the parameters of the disabling function become visible.
- On the parameter page "Kx - supplementary functions", set the parameter "polarity disabling object" to the desired polarity.

- Set the parameter "Behaviour at the beginning of the disabling function" to the required behaviour.

At the beginning of the disabling function, the configured behaviour will be executed and the bus control of the dimming channel locked. In the "no reaction" setting, the dimming channel shows no response and remains in the brightness state last selected.

In the "flashing" setting, the dimming channel is switched on and off cyclically during the disabling. The "time for flashing" is generally configured for all channels on the parameter page "General". During flashing, the logical switching state of the dimming channel is signalled back as "switched on 1" and the brightness value as "switch-on brightness". A soft ON/OFF function is not executed during flashing.

In the "Memory value" setting, the active and internally saved brightness value prior to switching off last time is set (via the "switching" or "central switching" object). After programming with the ETS, the value is predefined to maximum brightness. Only a bus voltage failure, however, does not delete the memory value.

i The "flashing" setting is not configurable in the "speed controller" operating mode for the "1-gang" device variant.

- Set the parameter "setting the behaviour at the end of the disabling function" to the required behaviour.

At the end of the disabling function, the configured behaviour will be executed and the bus control of the dimming channel enabled again. In the "No reaction" setting, the dimming channel shows no response and remains in the state last selected by the disabling function.

In "tracked brightness value", the set state received during the disabling function or adjusted before the disabling function can be tracked at the end of the disabling with the appropriate brightness. Any time functions that are still in progress will also be taken into account if necessary.

In the "flashing" setting, the output is switched on and off cyclically after the disabling. The flashing time is configured generally for all dimming channels on the parameter page "General". During flashing, the logical switching state of the channel is fed back as "switched on 1" and the brightness value as "switch-on brightness". A soft ON/OFF function is not executed during flashing. The flashing status remains active until another bus command is received and thereby predefines another brightness status.

In the "Memory value" setting, the active and internally saved brightness value prior to switching off last time is set (via the "switching" or "central switching" object). After programming with the ETS, the value is predefined to maximum brightness. Only a bus voltage failure, however, does not delete the memory value.

i The "flashing" setting is not configurable in the "speed controller" operating mode for the "1-gang" device variant.

i If, at the start or end of the disabling function a brightness value is configured, the selected value must not undershoot the set minimum brightness or exceed the maximum brightness in the ETS!

i After a bus failure or after programming the application or the parameters with the ETS, the disabling function is always deactivated (object value "0"). With the inverted setting "1 = enabled; 0 = disabled", a telegram update "0" must first be carried out after the initialisation until the disabling is activated.

i Updates of the disabling object from "activated" to "deactivated" do not produce a reaction.

i A dimming channel disabled via the KNX can be still be operated manually! At the end of a manual operation, the actuator executes the disabling reaction for the channel concerned once again if the disabling function is still activated at this time.

i In the setting "tracked brightness value": During a disabling function, the overridden functions of the actuator (switching, dimming, brightness value, scenes) continue to be executed internally. Consequently, newly received bus telegrams are evaluated and time functions are triggered as well. At the end of the disabling, the tracked states are set.

Setting forced position function as supplementary function

The forced position function, according to the function diagram, can also be combined with other functions of a dimming channel (Figure 34). With an active forced position the upstream functions are overridden so that the output concerned is locked.

The forced position function possesses a separate 2-bit communication object. The first bit (Bit 0) of the object "Forced position" indicates whether the dimming channel is switched off or switched on by force. If the dimming channel is switched on by force, an ETS parameter defines which brightness value it should be switched on to. The second bit (bit 1) activates or deactivates the forced-position state (see table below).

The behaviour of a dimming channel at the end of the forced-position function can be configured. In addition, the forced object can be initialised on bus voltage return.

Bit 1	Bit 0	Function
0	x	Forced position not active -> normal control
0	x	Forced position not active -> normal control
1	0	Forced position active: switch off
1	1	Forced position active: switch on to predefined brightness value

Bit coding of forced position

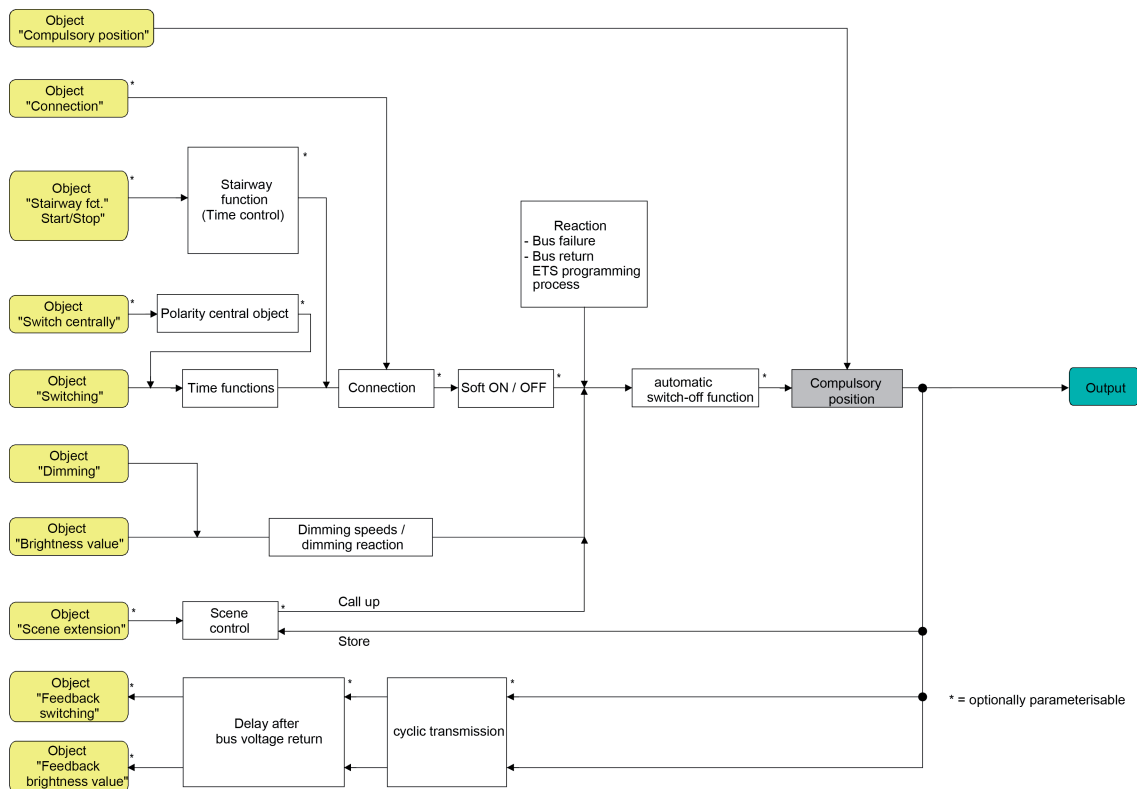

Figure 34: Function diagram of the forced position function

- On the parameter page "Kx - supplementary functions", set the parameter "type of supplementary function" to "forced position".

The forced position function is enabled. The communication object "forced position" and the parameter of the forced position function become visible.

- On the parameter page "Kx - supplementary functions", configure the parameter "switch on brightness for forced position 'active'" to the required behaviour that should be executed if a forced control is activated via the communication object.

When setting a brightness value, the dimming channel adjusts itself to the set brightness during a forced-position state. The forced brightness value selected must not exceed the maximum brightness configured in the ETS.

In the "No reaction" setting, the bus control of the dimming channel is locked, but the channel shows no response and remains in the brightness state last selected.

In the "Memory value" setting, the active and internally saved brightness value prior to switching off last time is set (via the "switching" or "central switching" object). After programming with the ETS, the value is predefined to maximum brightness. Only a bus voltage failure, however, does not delete the memory value.

- Set the parameter "brightness for forced position end 'inactive'" to the required behaviour.

At the end of the forced position, the configured behaviour will be executed and the bus control of the dimming channel enabled again. In the "No reaction" setting, the dimming channel shows no response and remains in the brightness state last selected by the forced position.

In "tracked brightness value", the state received during the forced position function or the brightness value adjusted before the function can be tracked at the end of the forced position. Any time functions still in progress will also be taken into account if necessary.

- i** The "switch off brightness for forced position 'active'" is preset to "switch off".
- i** Updates of the forced position object from "forced position active" to "forced position active" while maintaining the switching status or from "forced position inactive" to "forced position inactive" show no reaction.
- i** A forcibly activated dimming channel via the KNX can be still be operated manually! At the end of a manual operation, the actuator executes the forced reaction for the channel concerned once again if the forced position is still activated at this time.
- i** In the setting "tracked brightness value" at the end of the forced position: During a forced position, the overridden functions of the actuator (switching, dimming, brightness value, scenes) continue to be executed internally. Consequently, newly received bus telegrams are evaluated and time functions are triggered as well. At the forced end, the tracked states are set.
- i** The current state of the object of the forced position function will be stored in case of bus or mains voltage failure.

- Set the parameter "behaviour after bus voltage return" to the required behaviour.

After bus voltage return, the configured state is transferred to the "Forced position" communication object. When a forced position is activated, the dimming channel is immediately activated and interlocked accordingly by forced control after bus voltage return until a forced control takes place via the bus. The parameter "Behaviour after bus or mains voltage return" on the parameter page "Kx – General" will, in this case, not be evaluated for the dimming channel concerned.

In the "state before bus voltage failure" setting, the forced position state last selected and internally stored before bus voltage failure will be tracked after bus voltage return. An ETS programming operation deletes the stored state (reaction in that case same as with "no forced position active").

If the tracked state corresponds to "no forced position active", the force-independent parameter "Behaviour after bus/mains voltage return" will be executed on return of bus voltage (parameter page "Kx – General"). If the forced position is activated, the dimming channel is switched on to the brightness value predefined by the parameter "switch on brightness for forced position 'active'".

- i** After programming the application or parameters with the ETS, the forced position function is always deactivated (object value "0").

Setting logic operation function as supplementary function

A logic function can be parameterized separately for each dimming channel. This function allows the logic operation of the "switching" object state and an additional logic operation object. The state of the communication object for "switching" can also be evaluated with a time delay if a switch-on delay or switch-off delay is set.

The logic operation function, according to the function diagram, can also be combined with other functions of a dimming channel (Figure 35). A combination with the staircase function (time dimmer for the "speed controller") is not possible, however.

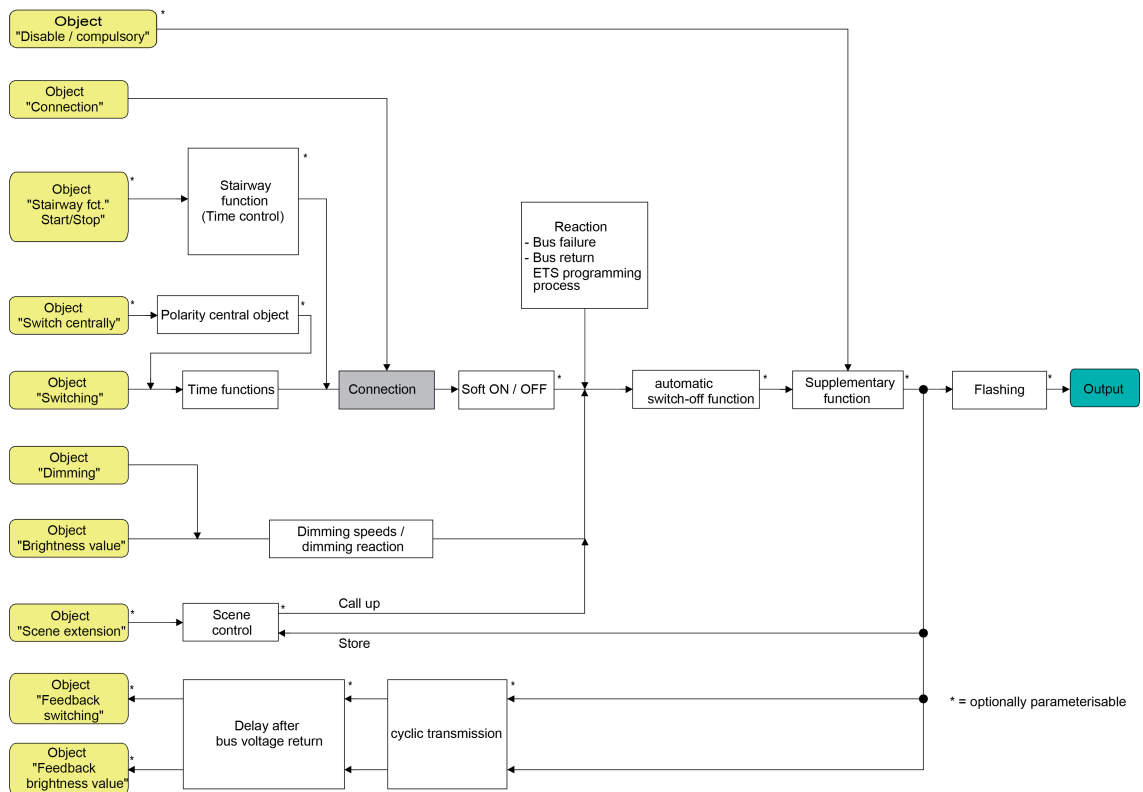

Figure 35: Function diagram of the logic operation function

The following logic operation types are configurable (Figure 36).

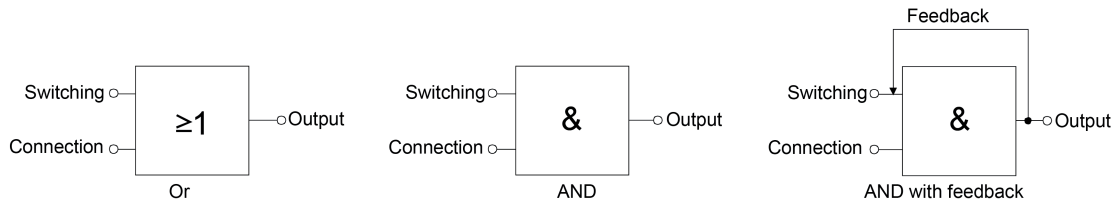

Figure 36: Logic operation types of the logic operation function

- i** "AND with feedback:"
 With a logic object = "0", the dimming channel is always "0" (logic AND). In this case, the feedback signal from the output to the "switching" input will directly reset this input when it is being set. The output of the dimming channel can assume the logical state "1" by a newly received "1" on the input "switching" only when the logic object is = "1".

The object "logic operation" can be installed with a preconfigured value after bus voltage return or after programming with ETS so that a correct logic operation result can be determined immediately and set on the output of the dimming channel during a telegram update on the "switching" object.

- On the parameter page "Kx - supplementary functions", set the parameter "Logic operation function" to "Yes". to "Yes".
 The logic operation function is enabled. The communication object "logic operation" and the parameters of the logic operation function become visible.
- Set the parameter "Type of logic operation function" to the desired logic operation type.
- Set the parameters "object value of the logic operation object after bus voltage return" and "object value of the logic operation object after ETS download" to the required initial states.
 The "logic operation" object is initialised immediately with the set switching states after bus voltage return or ETS programming of the application program or parameters.
- i** The logic operation function after a reset of the actuator (bus voltage return or programming with the ETS) is first executed when at least one input object of the logic operation is updated by a telegram from the bus.
- i** The states or switching states specified at the end of a disabling function or forced position function, which are set after programming in the ETS, in the case of bus voltage failure or after bus or mains voltage return, override the logic operation function. The configured logic operation is first re-executed and the result set on the output of the dimming channel when at least one input state of the logic operation is changed or updated.
- i** A mains voltage return does not influence the communication objects of the actuator. The objects remain on the last set state if the bus voltage was connected interruption free.

4.2.4.2.15 Dimming characteristic, dimming behaviour and dimming speeds

A dimming procedure can change the brightness (operating mode "lighting control") or speed (operating mode "speed controller") of the lamps connected to a dimming channel. The limits of the brightness/speed range adjustable by a dimming procedure is defined either by the basic brightness and maximum brightness predefined in the ETS, or alternately, by the combination of minimum brightness and maximum brightness.

- i** In the "speed controller" operating mode for the "1-gang" device variant - similar to the description of the brightness values for lighting control in this chapter - the speed values can be configured in the ETS. The differences between the "speed controller" operating mode compared to the "lighting control" operating mode can be read in detail in the chapter "Features in the speed controller operating mode" (see page 112).

A channel can be dimmed by...

- relative dimming:
Relative dimming can either be triggered by the 4-bit "dimming" communication object available separately in each dimming channel or by a long button-press of the manual operation. The data format of the "dimming" object complies with the KNX standard DPT "3.007", which means that the dimming direction and relative dimming increments can be predefined in the dimming telegram or dimming procedures can also be stopped. In relative dimming by local manual operation on the device, a dimming procedure is executed whilst the appropriate button is pressed. The dimming process ends when the button is released or when the basic/minimum brightness or maximum brightness is reached.
- absolute dimming:
Absolute dimming is triggered by specifying a brightness value. This value can be predefined by the 1-byte "brightness value" communication object from KNX the, which is available separately in each dimming channel. In addition, brightness values can also be set by a disabling or forced position function or by the scene function. Absolute dimming can also be activated, even in case of bus voltage failure, after bus or mains voltage return or after programming with the ETS, by predefined brightness values.
When predefined a brightness value via the object or by a scene recall, it is possible to configure in the ETS whether the value is jumped to directly or alternatively whether it is dimmed to via the configured dimming increment time or by fading. In the case of all other absolute dimming functions, the brightness values are always instantly jumped to.
- i** It is not possible to dim a speed value via "fading" in the "speed controller" operating mode for the "1-gang" device version.

The dimming speed is identical for a relative dimming procedure or for the dimming of an absolute brightness value (not fading) and can be set in the ETS separately for each dimming channel in the characteristic parameters.

- i** Even if brightness values are instantly jumped to, the dimming procedure on connected lamps always takes a very short time as well as when switching without soft ON or soft OFF. This dimming procedure is determined by the system. The brightness value instantly jumped to will be dimmed with the minimum increment of 1 ms. This time cannot be altered.

Configuring dimming characteristic

In the case of the universal dimmer actuator, the technically dimmable brightness range (basic brightness ... 100 %) is subdivided into 255 dimming increments (8-bit brightness value: 1...255 / 0 = switched off). In the as-delivered state of the actuator, the dimming increment times, i.e. the dimming times between 2 of 255 dimming increments, are set to the identical length. This results in a linear characteristic curve over the entire brightness range.

The dimmable brightness range is limited at the upper limit by the maximum brightness configured in the ETS. The lower brightness range is either defined by the basic brightness (brightness values "1", "2" and "3" -> "1 %") or alternatively, by the minimum brightness. The dimming characteristics shown in the following diagrams distinguish these configurations and illustrate the resulting real dimming time of a dimming procedure.

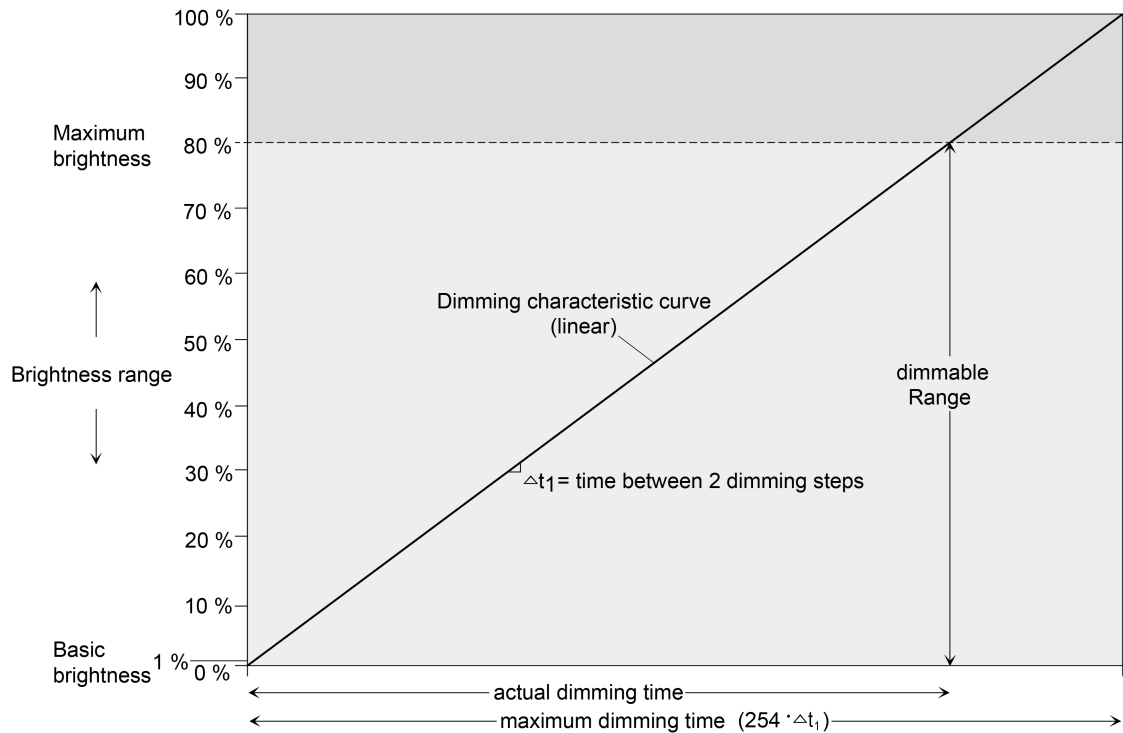

Figure 37: Linear dimming characteristic as an example with basic brightness and maximum brightness

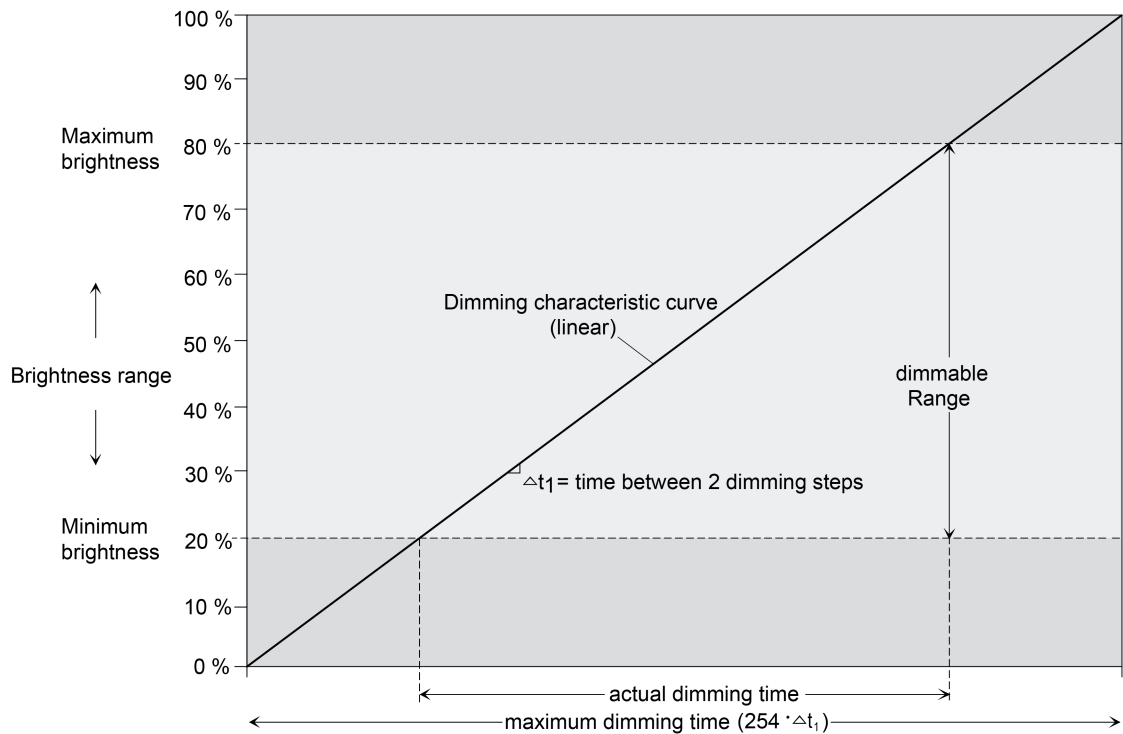

Figure 38: Linear characteristic dimming curve as an example with minimum brightness > 0 % and maximum brightness

In some practical applications, a linear dimming characteristic is not optimal. Hence, the actuator in the ETS alternatively permits a user-defined adjustment of the dimming progress. In this way, for example, brightness changes can be adjusted to the brightness sensitivity of the human eye when dimming by subdividing the brightness range in up to three sections with different dimming increment times.

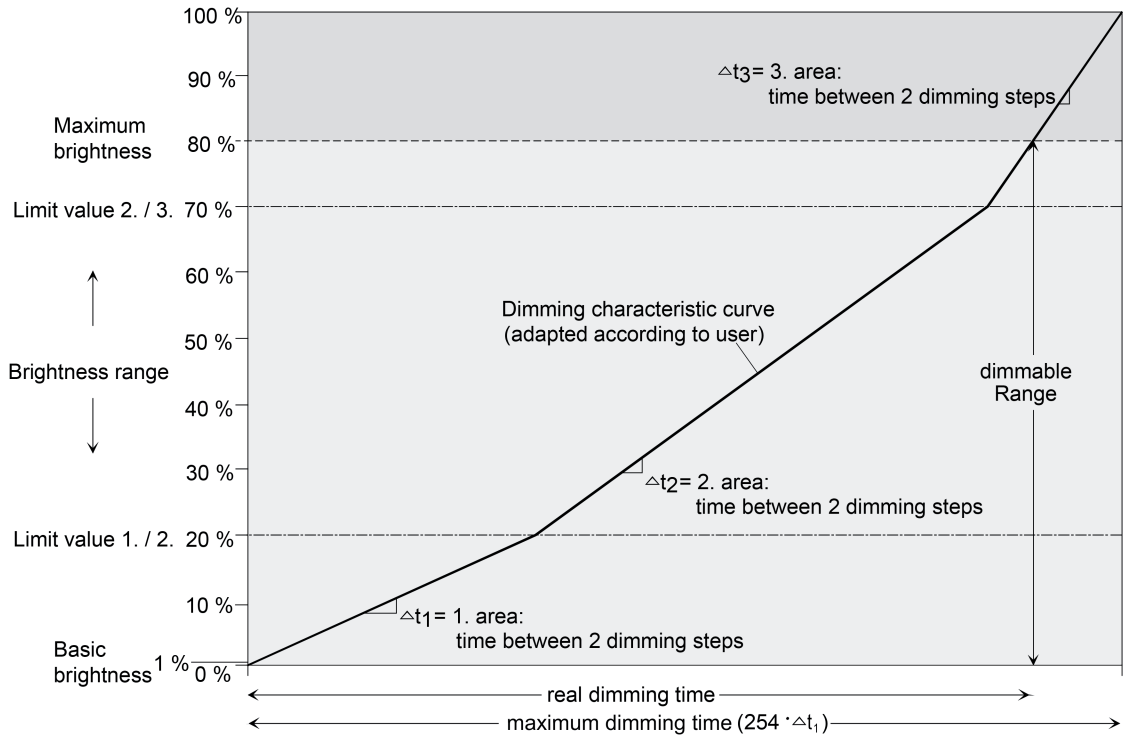

Figure 39: User-defined dimming characteristic as an example with basic brightness and maximum brightness

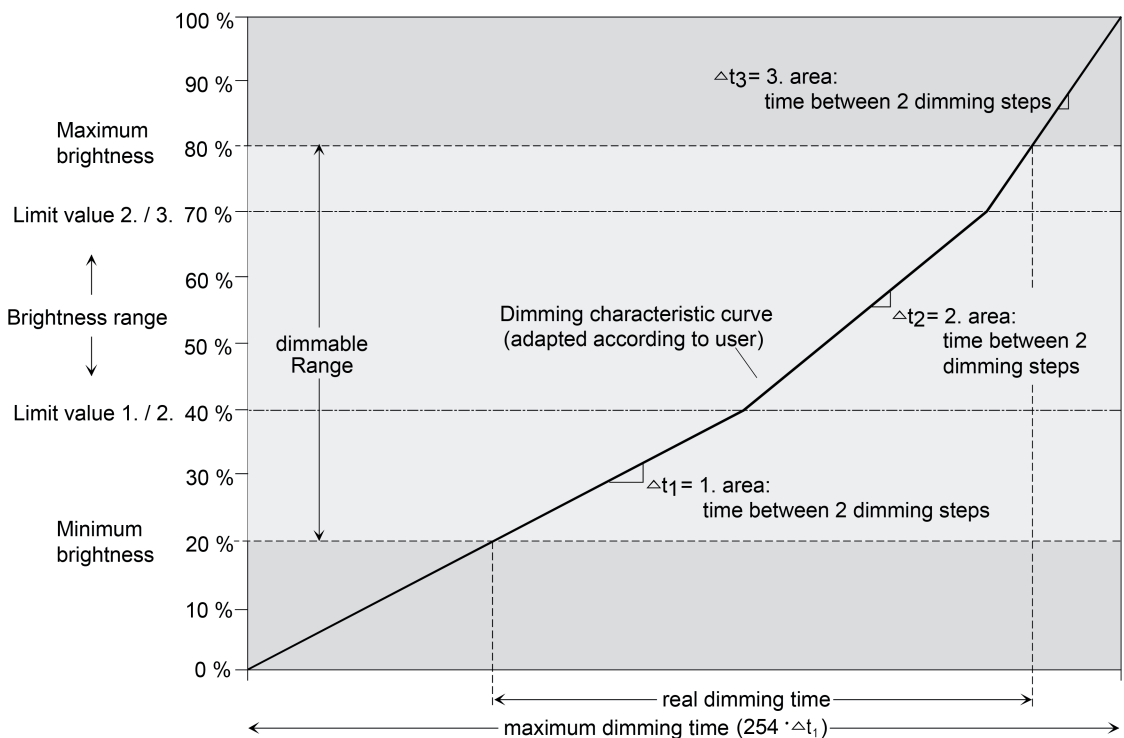

Figure 40: User-defined dimming characteristic as an example with minimum brightness and maximum brightness

As an additional option, it is possible to set predefined dimming characteristics for incandescent lamps or for halogen lamps in the characteristic parameterization. In this way, the dimming progress can be optimised for the named lamp loads. In this case, the dimming actuator works with fixed implemented brightness sections and dimming increment times. In the "speed controller" operating mode for the "1-gang" device variant, the load-optimised characteristic settings are available in the ETS.

- i** An increase of the brightness value in the dimmer actuator causes a time decrease of the residual phase angle. Likewise, a decrease of the brightness value on the dimmer output causes a time decrease of the residual phase angle. The residual phase angle determines, among other things, the dark phase of the connected lamps.
- Set the parameter "characteristic curve" on parameter page "Kx - dimming characteristic" (x = number of the dimming channel 1...4) to "linear".
A linear dimming characteristic curve is set. A dimming increment time can also be configured for the entire brightness range in the ETS.
 - Set the parameter "characteristic curve" to "user-defined".
A user-defined dimmer characteristic curve is set. Another two limiting values and three dimming increment times can be defined for the definition of three brightness sections.
 - Set the parameter "characteristic curve" to "adapted for incandescent lamps".
A specially adapted dimming characteristic curve is set for incandescent lamps. It is not necessary to carry out any further settings for the dimming characteristic.
- i** This setting is not available in the "speed controller" operating mode for the "1-gang" device variant.
- Set the parameter "characteristic curve" to "adapted for halogen lamps".
A specially adapted dimming characteristic curve is set for halogen lamps. It is not necessary to carry out any further settings for the dimming characteristic.
- i** This setting is not available in the "speed controller" operating mode for the "1-gang" device variant.

Setting dimming increment time

The dimming increment speed is identical for a relative dimming procedure or for the dimming of an absolute brightness value (not fading) and can be set in the ETS separately for each dimming channel in the characteristic parameters.

The configuration of a dimming increment time is only necessary if the characteristic curve is set to "linear" or to "user-defined".

The parameter "characteristic curve" is set to "linear".

- Set the parameter "time between two dimming increments" on parameter page "Kx - dimming characteristic" to the necessary dimming increment time.
During every relative or absolute dimming procedure, the entire brightness range is dimmed with the configured dimming increment speed.

The parameter "characteristic curve" is set to "user-defined".

- First define the brightness limit values. For this purpose, on the parameter page "Kx - Dimming characteristic" set the parameter "brightness limiting value 1. area / 2. area (1...100 %)" and "brightness limiting value 2. area / 3. area (1...100 %)" to the necessary section limits. While doing so, take care that the brightness limiting value of area 1. / 2. is smaller than the limiting value of area 2. / 3.! Otherwise, there is the risk of malfunction.
The dimmable brightness range is divided into three sections. In the following, the dimming increment speeds for these three areas can be set separately.

- i** In the configuration of the limiting value, care must be taken to ensure that the maximum brightness is not exceeded, or if necessary, the configured minimum brightness is not undershot.
 - The parameters "... time between two dimming increments (1...255 ms)" on parameter page "Kx - dimming characteristic" are set to the necessary dimming increment times for each of the three areas.

The dimming characteristic is defined ready. The lighting is dimmed at the specified dimming increment speeds for each of the three sections.
- i** The scene dimming increment speed for the dimming of scene values is defined separately in the scene parameters of an output (see page 92).

Setting dimming behaviour for absolute dimming

The dimming behaviour for the absolute dimming can be set separately in the ETS for each dimming channel via the "brightness value" or "speed" object.

- Set the parameter "dimming behaviour after receipt of a brightness value" on parameter page "Kx - General" (x = number of dimming channel 1...4) to "dim".

Once a new brightness value is received, it is set by means of the configured dimming increment time (see page 109-110) based on the predefined dimming characteristic.
- Set the parameter "dimming behaviour after receipt of a brightness value" to "jump to".

As soon as a new brightness value is received it will be instantly jumped to.
- Set the parameter "dimming behaviour after receipt of a brightness value" to "fading". In addition, on the parameter "Time for brightness value via fading", define the necessary fading time for dimming the scene brightness value.

Newly received brightness values will be dimmed. The dim fading is activated. The fading time defines the duration of the dimming procedure required to reach the new brightness value. The brightness value of a dimming channel on which the dimming starts and the configured dimming characteristic have no significance. The dimming procedure thus always requires the exact predefined time when specifying a new brightness value.
- i** The parameter setting "fading" is not available in the "speed controller" operating mode for the "1-gang" device variant.
- i** Brightness values can also be set by a disabling or forced position function. Absolute dimming can also be activated, even in case of bus voltage failure, after bus or mains voltage return or after programming with the ETS, by specifying brightness values. In the case of these absolute dimming functions, the brightness values are always instantly jumped to. During a scene recall, the dimming behaviour can be configured separately (see page 92).

Setting dimming behaviour in OFF state for relative dimming

A relative dimming process can be triggered by the 4-bit "dimming" communication object available separately in each dimming channel or by a long button-press of the manual operation. The data format of the "dimming" object complies with the KNX standard DPT "3.007", which means that the dimming direction and relative dimming increments can be predefined in the dimming telegram or dimming procedures can also be stopped. A relative dimming process is executed via the object until the configured basic minimum or maximum brightness of the dimming channel is set, the dimming value reaches the dimming increment predefined in the telegram or a stop telegram is received. A relative dimming process allows a brightness value to be changed constantly and always starts from the brightness that is set stationary or dynamically at the time of the incoming dimming telegram. A relative dimming telegram can also switch on a dimming channel if this is in the "OFF" state. In some applications, it may be necessary, however, for a switched off dimming channel to

remain off until a relative dimming telegram is received. This is interesting when using light scenes, for instance:

Several dimming channels are set to a defined brightness value via a light scene. Other channels are switched off by the scene. Only the brightness of channels not switched off by the scene recall should be changed by dimming up afterwards. Here, it is necessary for dimming channels not to react to a relative dimming operation and thus not to switch on.

The parameter "Behaviour when OFF by relative dimming" defines whether or not a dimming channel in the "OFF" state reacts to a relative dimming telegram.

- Set the parameter to "Dimming up switches channel ON (Standard)".

The dimming channel always reacts to a relative dimming telegram and executes a dimming process. In the "OFF" state, the channel switches on with a "dim up" telegram.

- Set the parameter to "Dimming up is ignored (channel remains OFF)".

The dimming channel only reacts to a relative dimming telegram when it is switched on. In the "OFF" state, the channel ignores a "dim up" telegram.

- i** In manual operation on the device, it is possible in the "OFF" state to always switch on and increase brightness by a long press of the button. The parameter "Behaviour when OFF by relative dimming" thus has no effect on manual operation.

4.2.4.2.16 Special features of the speed controller operating mode

Apart from controlling lighting, the universal dimmer actuator 1-gang can be used as a speed controller of single-phase electric motors. This operating mode can be preselected in the ETS and has a considerable effect on the parameter configuration and function of the device. In the function as speed controller, some parameters and object texts change because the speed of a connected motor is controlled in the "speed controller" operating mode instead of brightness. The speed (e.g. minimum speed) is configured in the ETS as a percentage value. This value represents the dimming value in percent and is a gauge for the output signal's phase angle of the actuator.

The differences between the "speed controller" operating mode compared to the "lighting control" operating mode will be described in more detail in the following...

Load type:

In the "Speed controller" operating mode, the dimming principle is preset to "phase cut-on". If the signalling object for load type is enabled, the actuator for the dimming channel always transmits the load type "inductive".

Cutting-in speed:

When changing from the "motor switched off" to "motor switched on" status via switching or dimming commands or after a device reset, the actuator first always sets the cutting-in speed. The cutting-in speed should ensure that the motor starts up optimally (e.g. reliable start-up of the fan motor through transfer of a higher torque, and thus a higher fan speed).

The dwell time that can be configured in the ETS determines how long the actuator allows the cutting-in speed to be active. The actuator changes to the predefined required speed only after the "dwell time in cutting-in speed" has elapsed. This change always occurs rapidly without a dimming procedure. If the required speed already corresponds to the cutting-in speed (100 %), there is no change.

If the motor should be switched off while the cutting-in speed is set, the actuator interrupts the dwell time and switches off the dimming channel immediately. This occurs rapidly without a dimming procedure. As a result, soft OFF functions configured optionally in the ETS will not be executed in this case.

i Required speed: The required speed results directly from switching commands via switching telegrams or via the manual operation. The required speed is then the cutting-in speed (Figure 41). Alternatively, the required speed is specified immediately via telegrams to the speed object or via speed specifications of the scene function or disabling and forced position functions (Figure 42).

In relative dimming via a 4-bit dimming telegram, the increment of the telegram specifies the dimming target and thus the required speed. If a relative dimming command is stopped via a stop telegram (e.g. pushbutton is released early), the point in time of the stop telegram decides which speed should be set as the required speed (Figure 43). If the stop telegram is received on the actuator during the dwell time of the cutting-in speed, the actuator will take into account the speed that was tracked and dimmed up in the background at the time of stopping as the required speed. If, however, the stop telegram arrives at the actuator after the dwell time of the cutting-in speed has elapsed, the actuator sets the speed predefined by the increment of the dimming telegram as the required speed. The stop telegram is rejected in this special case.

Push-buttons in the standard configuration normally transmit dimming increments of 100 %. The stop telegram then decides when a relative dimming procedure is aborted prematurely. If relative dimming is used in the "speed controller" operating mode and a relatively short dwell time is configured for the cutting-in speed, push-buttons should be reconfigured to smaller dimming increments with telegram repetition. This has the advantage that stop telegrams do not have to be transmitted in order to dim intermediate values of the possible dimming area.

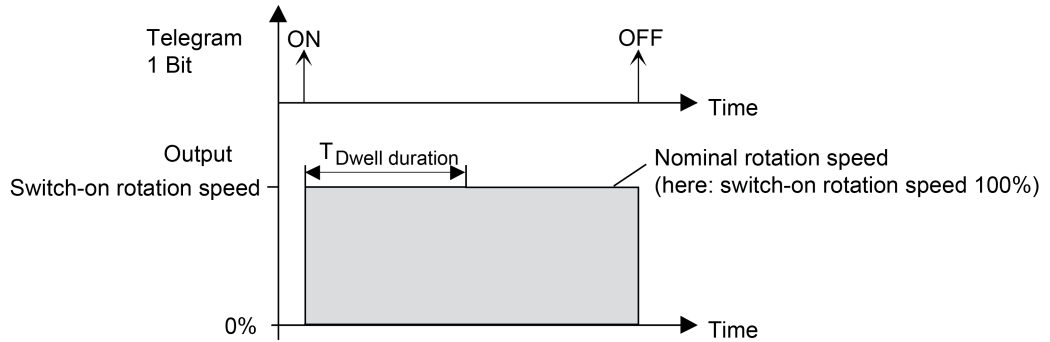

Figure 41: Cutting-in speed and required speed for switching commands

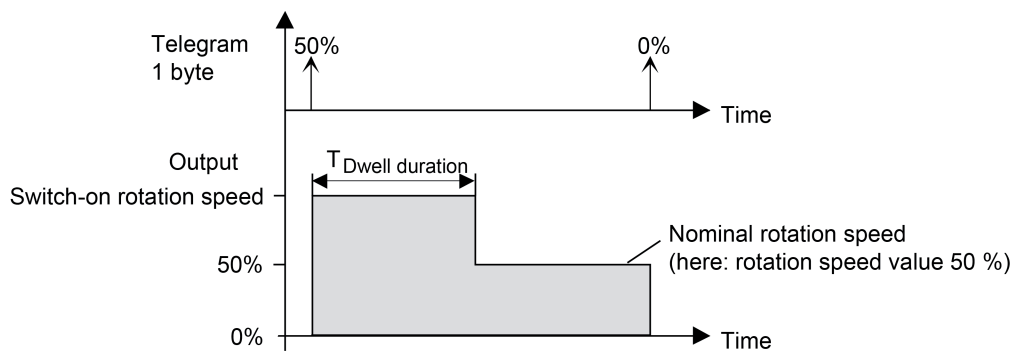

Figure 42: Cutting-in speed and required speed for value commands

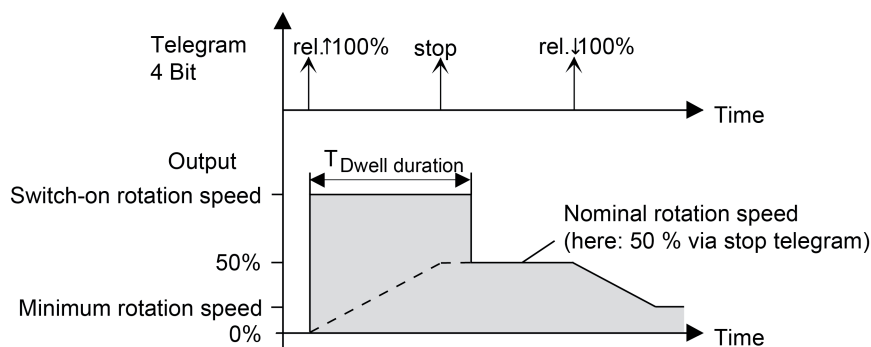

Figure 43: Cutting-in speed and required speed for relative dimming commands

i For the "1-gang" device variant in the "speed controller" operating mode it should be noted that the delay time of the switch-off function is set greater (see page 80) than the "dwell time in cutting-in speed"! Otherwise, after the dwell time elapses immediately after switching off a motor, the switch-on function will have no effect because the dwelling in the cutting-in speed has a higher priority.

Unnecessary settings:

In the "speed controller" operating mode, some configuration options are not necessary in the ETS owing to changed technical features of the load. The following parameter settings are modified as compared to the "lighting control" operating mode...

- The maximum speed cannot be adjusted by means of a parameter. It is preset to 100 %.
- The load failure message cannot be configured.
- In the "dimming behaviour after receipt of a speed value" parameter, the "fading" setting is not necessary.
- In the scene configuration, the "dim speed via fading" setting is not necessary.
- In the switch-on/switch-off behaviour, the "soft ON function" is not necessary.
- In the disabling function, the "flashing" reaction cannot be configured.
- The supplementary function "time extension" is not necessary in the time dimmer function.
- In the "linear dimming characteristic curve" the settings "adapted for incandescent lamps" and "adapted for halogen lamps" are not necessary.

4.2.4.3 Delivery state

In the state as delivered, the device is passive, i.e. no telegrams are transmitted to the bus. The connected loads can, however, be operated by manual operation on the device if the mains voltage is on. In the manual control mode, no feedback telegrams are sent to the bus. Other functions of the device are deactivated.

The device can be programmed and put into operation via the ETS. The physical address is preset to 15.15.255

Moreover the device has been configured at the factory with the following characteristics...

- Operating mode: lighting control
- Channel definition: 4 separate dimming channels
- Dimming principle: universal
- Time between two dimming increments manual operation: 12 milliseconds
- Basic brightness: level 5 (standard halogen)
- Maximum brightness: 100 %
- Switch-on brightness: 100 %
- Behaviour in case of bus voltage failure: no reaction
- Behaviour after bus voltage return: last brightness value.
- Behaviour on the load outputs after mains voltage return: The device calibrates itself to the load outputs. This procedure depends on the features of the power supply can last up to 10 seconds. The outputs switch off afterwards.
- Operating hours counter: deactivated.
- Behaviour at the end of manual control: no change.

The as-delivered state can be restored at any time by loading the application program with the aid of the ETS. The manual operation remains activatable in this case.

- i** When connecting a motor "speed controller" operating mode only for "1-gang" device variant) or parallel wired dimming outputs (for "4-gang" device variant), after the installation, commissioning using the ETS is essential before switching on the mains voltage (see page 16-17) so that the as-delivered state is replaced by the necessary parameter configuration!

4.2.5 Parameters

Description	Values	Comment
<p>□ Channel definition</p> <p>Setting the channel parameters</p>	<p>all channels equal</p> <p>each channel individual</p>	<p>To simplify the configuration, all existing dimming channels can be assigned to the same parameters in the ETS and thus configured identically. This parameter stipulates whether every dimming channel of the device can be configured individually or whether all channels should be configured by the same parameters.</p> <p>In the "all channels equal" setting, the number of parameters in the ETS is reduced. The visible parameters are then used on all channels automatically. Only the communication objects can then be configured separately for the channels. This setting should be selected, for example, if all channels behave identically and should only be activated by different group addresses (e.g. in office blocks or in hotel rooms). In the "each channel individual" setting, all dimming channels of the device can be configured autonomously.</p> <p>To increase the channel dimmer output power, the "4-gang" device variant in particular can be wired in parallel by reducing the number of channel outputs. The assignment of parallel to wired dimming outputs to the KNX-controllable dimming channels takes place in the ETS. The following parameters define how many dimming channels should be used. The fewer channels that are configured, the more dimming outputs can be assigned to a channel by the parameter "effect".</p>
Use dimming channel 1?	Yes No	Define whether the first dimming channel should be used. This parameter is also preset to "Yes" because a dimming channel is always available. This parameter is only visible in the device variant "4-gang".
Use dimming channel 2?	Yes No	Define whether the second dimming channel should be used. If the setting is "Yes", the second dimming channel is available. If the setting is "No", the dimming channels 2...4 are not available. The actuator then works as a 1-channel device.

		<p>This parameter is always preset to "Yes" if the parameter configuration in the ETS is identical (see parameter "Setting the channel parameters").</p> <p>This parameter is only visible in the device variant "4-gang".</p>
Use dimming channel 3?	<p>Yes</p> <p>No</p>	<p>Define whether the third dimming channel should be used. If the setting is "Yes", the third dimming channel is available. The actuator then works as a 3-channel device at least. If the setting is "No", the dimming channels 3 & 4 are not available. The actuator then works as a 2-channel device, if the parameter "use dimming channel 2?" is set to "Yes".</p> <p>This parameter is only visible in the device variant "4-gang".</p>
Use dimming channel 4?	<p>Yes</p> <p>No</p>	<p>Define whether the fourth dimming channel should be used. If the setting is "Yes", the fourth dimming channel is available. The actuator then works as a 4-channel device. If the setting is "No", dimming channel 4 is not available. The actuator then works as a 1, 2 or 3-channel device, depending on how the parameters "use dimming channel 2?" and "use dimming channel 3?" are set. This parameter is only visible in the device variant "4-gang".</p>
		<p>The assignment of the KNX controllable dimming channels to the dimming outputs is described in the assignment table for the device variant "4-gang", which is stored in the device. The assignment of dimming channel 1 to the outputs can only be configured in 2-channel and 3-channel operation. This then gives rise to the effect of the other channels on the outputs. The "Effect of channel 1" parameter defines the assignment and, irrespective of this, specifies the effect of the other channels.</p>

		<p>i The configuration of the effect has influence on the parallel wiring of the 4 dimmer outputs and thus has influence on the load distribution. The effect cannot be configured with the device variants "1-gang" and "2-gang". The assignment of dimming channels to the outputs must be predefined directly by the channel number.</p>
Effect of channel 1	<p>Output 1 (max. 250 W) Outputs 1-2 (max. 500 W) Outputs 1-3 (max. 750 W) Outputs 1-4 (max. 1,000 W)</p>	<p>Define which outputs the first dimming channel affects. The outputs assigned here to dimming channel 1 can be wired in parallel if more than one output was assigned. The choice of parameter is limited if necessary, depending on the number of dimming channels available.</p>
Effect of channel 2	<p>Output 2 (max. 250 W) Output 3 (max. 250 W) Output 4 (max. 250 W) Outputs 2-4 (max. 750 W) Outputs 3-4 (max. 500 W)</p>	<p>Define which outputs the second dimming channel affects. The outputs assigned here to dimming channel 2 can be wired in parallel if more than one output was assigned. This parameter presetting depends on the effect of the first dimming channel.</p>
Effect of channel 3	<p>Output 3 (max. 250 W) Output 4 (max. 250 W) Outputs 3-4 (max. 500 W)</p>	<p>Define which outputs the third dimming channel affects. The outputs assigned here to dimming channel 3 can be wired in parallel if more than one output was assigned. This parameter presetting depends on the effect of the first dimming channel.</p>
Effect of channel 4	<p>Output 4 (max. 250 W)</p>	<p>Define which output the fourth dimming channel affects. If all 4 dimming channels are used, channel 4 can only affect output 4.</p>
		<p>i On the parameter page "Connection help", a summary of the channel assignment and possible connected load of the individual dimming channels is displayed. The information on this page can help the electrician to connect the electrical load to the dimming outputs and hence to assign it to the KNX-controllable dimming channels when installing the device.</p>

□ General

Delay after bus voltage return Minutes (0...59)	0...59	To reduce telegram traffic on the bus line after bus voltage activation (bus reset), after connection of the device to the bus line or after programming with the ETS, it is possible to delay all active feedback telegrams of the actuator. The parameter specifies in this case a delay valid for all devices. Only after the time configured here has elapsed are feedback telegrams for initialisation transmitted to the bus.
		Setting the delay time minutes.
Seconds (0...59)	0...17...59	Setting the delay time seconds.
Central function for blind outputs?	Yes No	Setting "yes" enables the central function and thus the "Central switching" object. An assignment of individual dimming channels to the central function is only possible if the function is enabled.
Central object polarity	0 = deactivated; 1 = activated 0 = activated; 1 = deactivated	This parameter defines the polarity of the central object. This parameter is visible only if the central function is enabled.
Blinking rate	1 sec 2 sec 3 sec 10 sec	At the start and end of the "disable" supplementary function, a dimming channel can flash. The flash cycle time is generally set here for all dimming channels concerned. This parameter is not visible in the "speed controller" operating mode for the "1-gang" device variant.
□ Times		
Time for cycl. transm. of the feedback Hours (0...23)	0...23	The transmitting feedback telegrams of the actuator can, depending on the parameterisation, also transmit their state cyclically to the bus. The parameter "Time for cyclical transmission of feedback tel." generally defines the cycle time for all dimming channels.
		Sets the cycle time hours.
Minutes (0...59)	0...2...59	Sets the cycle time minutes.
Seconds (10...59)	10...59	

		Sets the cycle time seconds.
Time for cycl. transm. of operating hours Hours (0...23)	0... 23	The operating hours counters - depending on the parameterisation - can also transmit their counter value cyclically to the bus. The parameter "Time for cyclical transmission of feedback tel." Generally defines the cycle time for all dimming channels.
Minutes (0...59)	0 ...59	Sets the cycle time hours.
Seconds (10...59)	10 ...59	Sets the cycle time minutes. Sets the cycle time seconds.
<input type="checkbox"/> Manual operation		
Manual control in case of bus voltage failure	Disabled Enabled	This parameter can be used for programming whether manual control is to be possible or deactivated in case of bus voltage failure.
Manual control during bus operation	Disabled Enabled	This parameter can be used for programming whether manual control is to be possible or deactivated during bus operation (bus voltage on).
Disabling function ?	Yes No	Manual control can be disabled via the bus, even if it is already active. For this purpose, the disabling object can be enabled here. This parameter is only visible if manual control is enabled during bus operation.
Polarity of disable object	0 = enabled; 1 = disabled 0 = disabled; 1 = enabled	This parameter sets the polarity of the disabling object. This parameter is only visible if manual control is enabled during bus operation.
Transmit status ?	Yes No	The current state of manual control can be transmitted to the bus via a separate status object, if bus voltage is available (setting: "Yes"). This parameter is only visible if manual control is enabled during bus operation.
Status object function and polarity		This parameter defines the information contained in the status object. The object is always "0", when the manual control mode is deactivated.

		This parameter is only visible if manual control is enabled during bus operation.
	0 = inactive; 1 = man.contr.active	The object is "1" when the manual control mode is active (temporary or permanent).
	0 = inactive; 1 = perman. man. control active	The object is "1" only when the permanent manual control is active.
Behaviour at the end of permanent manual control during bus operation	No change	The behaviour of the actuator at the end of permanent manual control depends on this parameter. This parameter is only visible if manual control is enabled during bus operation. All telegrams received during an active permanent manual control mode for direct operation (switching, dimming, brightness value, scenes) will be rejected. After the end of the permanent manual control mode, the current state of all outputs remains unchanged. If, however, a forced position or disabling function has been activated before or during manual operation, the actuator resets the reaction configured for this function for the dimming channels concerned.
	output tracking	During active permanent manual control all incoming telegrams are tracked internally. At the end of the manual operation, the outputs will be set according to the last command or state received before manual operation.
Bus control of single channels during bus operation can be disabled?	Yes No	Individual outputs can be disabled locally during permanent manual control, so that the disabled outputs can no longer be controlled via the bus. Disabling via manual control is only permitted if this parameter is set to "Yes". i This parameter is only visible if manual control is enabled during bus operation.
<input type="checkbox"/> Kx - General Operating mode		Apart from controlling lighting, the actuator "1-gang" device variant can be used as a speed controller of single-phase electric motors. The operating mode is preselected by this parameter and has a considerable effect on the parameter configuration and function of the device.

	<p>i The operating mode is not adjustable with the device variants "2-gang" and "4-gang". The lighting operation is always intended here.</p>
Lighting control	<p>In the "Lighting control" function, the dimming principle can be selected in the ETS. Lighting systems in leading edge phase control or trailing edge phase control are then activated by switching or dimming commands and brightness values.</p>
Speed controller	<p>In the function as a "speed controller", the dimming principle is predefined to leading edge phase control. Some parameter and object texts change because in the "speed controller" operating mode the speed of a connected motor is controlled instead of brightness. The speed (e.g. minimum speed) is configured in the ETS as a percentage value. This value represents the dimming value in percent and is a gauge for the output signal's phase angle of the actuator.</p>
Type of connected load	<p>The dimming principle of the dimming channel is specified here. This parameter is preset to "Motor (inductive / leading edge phase control)" in the "speed controller" operating mode for the "1-gang" device variant).</p>
universal (with calibration procedure)	<p>The dimming channel calibrates itself universally to the connected load type. After programming with the ETS, after bus voltage return (without mains voltage), after mains voltage return on the terminal pair "L N" (without bus voltage) or after switching on the mains voltage supply of a load output, the actuator calibrates itself automatically to the connected load. The calibration procedure becomes noticeable during ohmic loads by a brief flicker and lasts up to 10 seconds depending on the network conditions.</p>
electronic transformer (capacitive / trailing edge phase control)	<p>This setting is only available in Version "1.2" of the application program and, as described, only effective with device generations up to "V03". The dimming channel is preset to trailing edge phase control principle. There is no automatic calibration of the load type. Ohmic loads or electronic transformers can be connected to the output.</p>
electr. transformer / LV- LED (capacitive / trailing edge phase control)	<p>This setting is only available in Version "1.3" of the application program and, as described, only effective with device generations from "V04".</p>

	The dimming channel is preset to trailing edge phase control principle. There is no automatic calibration of the load type. Ohmic loads, electronic transformers or LV-LEDs (via Tronic transformers) can be connected to the output.
Conventional transformer (inductive / leading edge phase control)	This setting is only available in Version "1.2" of the application program and, as described, only effective with device generations up to "V03". The dimming channel is preset to leading edge phase control principle. There is no automatic calibration of the load type. Conventional transformers can be connected to the output.
conv. transformer / LV-LED (inductive / leading edge phase control)	This setting is only available in Version "1.3" of the application program and, as described, only effective with device generations from "V04". The dimming channel is preset to leading edge phase control principle. There is no automatic calibration of the load type. Conventional transformers or LV-LEDs (via conv. transformers) can be connected to the output.
LED (trailing edge phase control)	This setting is only available in Version "1.2" of the application program and, as described, only effective with device generations from "V02". The dimming channel is preset to an optimized trailing edge phase control principle. There is no automatic calibration of the load type. HV LED or compact fluorescent lamps optimized for this dimming principle can be connected to the output.
HV-LED (trailing edge phase control)	This setting is only available in Version "1.3" of the application program and, as described, only effective with device generations from "V04". The dimming channel is preset to an optimized trailing edge phase control principle. There is no automatic calibration of the load type. HV LED or compact fluorescent lamps optimized for this dimming principle can be connected to the output.
LED (leading edge phase control)	This setting is only available in Version "1.2" of the application program and, as described, only effective with device generations from "V02". The dimming channel is preset to an optimized leading edge phase control principle. There is no automatic calibration of the load type. HV LED or compact fluorescent lamps optimized for this dimming principle can be connected to the output.

	HV-LED (leading edge phase control)	<p>This setting is only available in Version "1.3" of the application program and, as described, only effective with device generations from "V04".</p> <p>The dimming channel is preset to an optimized leading edge phase control principle. There is no automatic calibration of the load type. HV LED or compact fluorescent lamps optimized for this dimming principle can be connected to the output</p>
Operation with universal power booster ?		<p>If the output power is increased by means of universal power boosters, the corresponding channel configuration of the dimmer actuator must be adapted here. The dimmer actuator adapts the output signal automatically for using universal power boosters based on the setting of this parameter.</p>
	Yes	<p>At least one universal power booster is connected to the dimming channel. In the highest dimming position (100 % brightness value), a residual phase angle necessary for universal power boosters is set on the dimmer output. The output signal cut-on or cut-off in this way corresponds to a resulting brightness of approx. 90 % compared to an identically constructed dimmer actuator without a power booster. The dimmer actuator rescales the adjustable brightness range automatically for the corresponding channel so that a presetting and feedback within a range of 0...100% is still possible.</p>
	No	<p>No universal power booster is connected to the dimming channel. In the highest dimming position (100 % brightness value), the smallest possible residual phase angle is set on the dimmer output. As a result, the connected lighting is set to the maximum lighting level technically possible.</p>
Definition of the brightness range	<p>with basic brightness with minimum brightness</p>	<p>The brightness range, adjustable by switching or dimming procedures, can be limited by defining a lower and upper brightness value. The lower brightness value is either defined by the basic brightness, or alternatively, by the minimum brightness. The upper brightness value is always characterised by the maximum brightness. The</p>

		<p>maximum brightness adjustable in the ETS is never exceeded under any circumstances in the switched-on operating state of a dimming channel. Neither when switching on nor when dimming.</p> <p>This parameter defines whether the adjustable brightness range at the lower limit will be limited by the basic brightness or by a minimum brightness. This parameter is visible only in the "lighting control" operating mode.</p>
Basic brightness	<p>Level 1 Level 2 Level 3 (Incandescent lamps) Level 4 Level 5 (standard halogen) Level 6 Level 7 Level 8</p>	<p>The step value set here is a gauge for the minimum adjustable residual phase angle of the output signal and is set to the decimal brightness values "1", "2" and "3". The step value cannot be undershot in any switched-on operating state of the dimming channel.</p> <p>This parameter is visible only if the "definition of the brightness range" includes the "basic brightness" and the "lighting control" operating mode is also predefined.</p>
Minimum brightness	<p>1 % 5 % 10 % 15 % 20 % 25 % 30 % 35 % 40 % 45 %</p>	<p>The brightness set here is not undershot in any switched-on operating state. This parameter is visible only if the "definition of the brightness range" includes the "minimum brightness" and the "lighting control" operating mode is also predefined.</p>
Minimum speed	<p>1 % (decimal 3) 5 % (decimal 13) 10 % (decimal 26) 15 % (decimal 38) 20 % (decimal 51) 25 % (decimal 64) 30 % (decimal 77) 35 % (decimal 89) 40 % (decimal 102) 45 % (decimal 115)</p>	<p>The speed set here is not undershot in any switched-on operating state. During the initial commissioning, the device must be adapted to the minimum speed of the connected motor by this parameter.</p> <p>This parameter is visible only if the "speed controller" operating mode is predefined.</p>
Maximum brightness	<p>Basic brightness 5 % 10 % 15 % ... 95 % 100 %</p>	<p>The brightness set here is not undershot in any switched-on operating state. The selection of the adjustable value is downwardly limited to 50 % when using a minimum brightness. Smaller values cannot be configured in this case because otherwise the adjustment range of the minimum brightness will be cut</p>

		(minimum brightness < maximum brightness). This parameter is visible only in the "lighting control" operating mode. In the "speed controller" operating mode the maximum speed is unalterably preselected to 100 %.
Cutting-in speed	100 %	The parameter is only visible in the "speed controller" operating mode for the "1-gang" device variant. When changing from the "motor switched off" to "motor switched on" status via switching or dimming commands or after a device reset, the actuator first always sets the cutting-in speed. The cutting-in speed should ensure that the motor starts up optimally (e.g. reliable start-up of the fan motor through transfer of a higher torque, and thus a higher fan speed). The cutting-in speed is unalterably predefined as 100 %.
Dwell time in cutting-in speed Seconds (0...59)	0...2...59	The parameter is only visible in the "speed controller" operating mode for the "1-gang" device variant. The dwell time that can be configured here determines how long the actuator allows the cutting-in speed to be active. The actuator changes to the predefined required speed only after the dwell time for the cutting-in speed has elapsed. This change always occurs rapidly without a dimming procedure. If the required speed already corresponds to the cutting-in speed (100 %), there is no change. If the motor should be switched off while the cutting-in speed is set, the actuator interrupts the dwell time and switches off the dimming channel immediately. This occurs rapidly without a dimming procedure. As a result, soft OFF functions configured optionally in the ETS will not be executed in this case.
Milliseconds (5...9 * 100)	5...9	Sets the dwell time seconds. Sets the dwell time milliseconds.
Behaviour after ETS programming		The actuator permits setting the brightness value separately for each dimming channel after programming with the ETS.
	switch off	The dimming channel is switched off.

	Basic brightness 5 % 10 % 15 % ... 95 % 100 %	The dimming channel is set to the predefined brightness value or speed (pay attention to configured minimum and maximum brightness!). The "basic brightness" setting is only available if the dimming range is limited to the lower limit by the basic brightness. Furthermore, this setting is not available in the "speed controller" operating mode.
	No reaction	After programming with the ETS, the dimming channel shows no response and remains in the switching brightness value currently selected.
Behaviour in case of bus voltage failure		The actuator permits setting the brightness value separately for each dimming channel in case of bus voltage failure.
	switch off	The dimming channel is switched off. It should be noted that the configured OFF command can only be executed if the mains voltage supply of the actuator (terminal pair "L N") is switched on. If the mains voltage is switched off, the actuator in this configuration shows no reaction (the last brightness state remains active provided that the mains voltage on the dimming outputs is still switched on).
	Basic brightness 5 % 10 % 15 % ... 95 % 100 %	The dimming channel is set to the predefined brightness value or speed (pay attention to configured minimum and maximum brightness!). It should be noted that the brightness value or speed can only be set if the mains voltage supply of the actuator (terminal pair "L N") is switched on. If the mains voltage is switched off, the actuator in this configuration shows no reaction (the last brightness state remains active provided that the mains voltage on the dimming outputs is still switched on). The "basic brightness" setting is only available if the dimming range is limited to the lower limit by the basic brightness. Furthermore, this setting is not available in the "speed controller" operating mode.
	No reaction	In case of bus voltage failure, the dimming channel shows no reaction and remains in the currently set brightness value, provided that the mains voltage on the dimming outputs is still switched on.

Behaviour after bus or mains voltage return		<p>The actuator allows the brightness value or speed to be set separately for each dimming channel after bus voltage return. This parameter also defines the behaviour after mains voltage return if there is no bus voltage on the actuator at the time of mains return (on the terminal pair "L N"). If there is bus voltage at the time of mains return, the parameter will not be executed!</p>
	switch off	The dimming channel is switched off.
	Basic brightness	The dimming channel is set to the predefined brightness value or speed (pay attention to configured minimum and maximum brightness!).
	5 %	The "basic brightness" setting is only available if the dimming range is limited to the lower limit by the basic brightness.
	10 %	Furthermore, this setting is not available in the "speed controller" operating mode.
	15 %	
	...	
	95 %	
	100 %	
	Brightness value / speed before bus voltage failure	After bus or mains voltage return, the value last set before bus voltage failure and internally stored on bus voltage failure will be tracked.
	No reaction	After bus or mains voltage return, the dimming channel shows no response and remains in the state currently selected.
	Activating staircase function	The staircase function is – irrespective of the 'Switching' object - activated after bus or mains voltage return. With this setting, make sure that the staircase function is also enabled. When the staircase function is not enabled, there is no reaction after bus/mains voltage return with this setting. In the "speed controller" operating mode for the "1-gang" device variant, this parameter setting is called "activate time dimmer function".
Switch-on brightness	Basic brightness	<p>This parameter specifies the brightness value, which should be set whenever switching on via the "switching" or "central switching" object or by manual operation on the dimming channel. The switch-on brightness must always be between the upper and lower brightness limit value of the dimming range. The selection of "basic brightness" is not necessary when using a minimum brightness.</p> <p>This parameter is visible only in the "lighting control" operating mode.</p> <p>In the "Memory value" setting, the active and internally saved brightness value</p>
	5 %	
	10 %	
	15 %	
	...	
	100 %	

	Memory value (brightness before switching off last time)	prior to switching off last time is set when switching on (via the "switching" or "central switching" object).
Dimming behaviour after receipt of a brightness value	jumping to dimming to fading	A parameter is used here to define whether a brightness value received via the bus is instantly jumped to (absolute dimming), or whether the brightness is dimmed to via the set dimming characteristic. Fading is also possible as an alternative. When fading, the received brightness value is reached in the exact configured fading time irrespective of the dimming characteristic and irrespective of which brightness value the dimming procedure was started at. Thus, for example, several dimming outputs can be set to the same brightness at the same time. It is not possible to dim a speed value via "fading" in the "speed controller" operating mode for the "1-gang" device version. Hence, this setting is not necessary in the operating mode mentioned.
Time for brightness value via fading Seconds (0...59)	0... 20 ...59	The fading time is set here if fading is predefined in the dimming behaviour. A dimming procedure via fading lasts for the exact configured time. If "0" is set, the brightness value is jumped to directly.
Behaviour by relative dimming when OFF	Dimming up switches channel ON (Standard) Dimming up is ignored (channel remains OFF)	This parameter defines whether or not a dimming channel in the "OFF" state reacts to a relative dimming telegram. The dimming channel always reacts to a relative dimming telegram and executes a dimming process. In the "OFF" state, the channel switches on with a "dim up" telegram. The dimming channel only reacts to a relative dimming telegram when it is switched on. In the "OFF" state, the channel ignores a "dim up" telegram.
Assignment to central function ?	Yes No	This parameter determines the assignment of the dimming channel to the central function. This parameter is visible only if the central function is enabled (parameter page "General").

☐ Kx - Enabled functions

Feedback telegrams	disabled enabled	This parameter can be used to disable or to enable the feedback functions. When the function is enabled, the required parameters will be displayed under "Kx –Feedbacks".
Time delays	disabled enabled	This parameter can be used to disable or to enable the time delays. When the function is enabled, the required parameters will be displayed under "Kx –Time delays".
Staircase function	disabled enabled	This parameter can be used to disable or to enable the staircase function. When the function is enabled, the corresponding parameters will be displayed under "Kx Staircase function" and the necessary object enabled. In the "speed controller" operating mode for the "1-gang" device variant, this parameter setting is called "time dimmer function".
Switch-on/switch-off behaviour	disabled enabled	The functions that influence the switch-on and switch-off behaviour of the dimming channel can be disabled or enabled here. When the functions are enabled, the required parameters will be displayed under "Kx –Switch-on/switch-off behaviour".
Scene function	disabled enabled	This parameter can be used to disable or to enable the scene function. When the function is enabled, the corresponding parameters will be displayed under "Kx -Scenes" and the necessary object enabled.
Operating hours counter	disabled enabled	The operating hours counter can be disabled or enabled here. When the function is enabled, the corresponding parameters will be displayed under "Kx -Operating hours counter" and the necessary object enabled. <div style="border: 1px solid black; padding: 2px; display: inline-block;"> i If the operating hours counter is disabled, any operating hours that may have been counted previously will be deleted and any limiting or start values predefined via the object for the dimming channel concerned will be reset! </div>

Signal short-circuit ?

	Yes No	This parameter can be used to enable the short-circuit message. The corresponding communication object becomes visible when enabled.
Signal load failure / overload ?	Yes No	This parameter can be used to enable the load failure or overload message. The corresponding communication object becomes visible when enabled. The parameter for the load failure/overload message is not available in the "speed controller" operating mode for the "1-gang" device variant.
Signal load type ?	Yes No	This parameter can be used to enable feedback of the load type. The corresponding communication object becomes visible when enabled.
<input type="checkbox"/> Kx - Feedbacks Feedback switching status ?	 no feedback	The current switching state of the dimming channel can be signalled back separately to the bus. No feedback object available for the switching status. Switching status feedback deactivated.
	Feedback object is active signalling object	The "Switching feedback" object is enabled. The switching status is transmitted once the status is updated. An automatic telegram transmission of the feedback takes place after bus voltage return or after programming with the ETS.
	Feedback object is passive status object	The "Switching feedback" object is enabled. The switching status will be transmitted in response only if the feedback object is read out from by the bus. No automatic telegram transmission of the feedback takes place after bus voltage return or after programming with the ETS.
Updating the object value for switching status feedback	after each update obj. "Switching"/"Central"	Here you can specify when the actuator should update the feedback value for the switching status in case of an actively transmitting communication object. The object value updated by the actuator is then signalled actively to the bus. The actuator updates the feedback value in the object once a new telegram is received on the input objects

		<p>"Switching" or "Central switching". With an actively transmitting feedback object, a new telegram is also then actively transmitted to the bus each time. The telegram value of the feedback does not necessarily have to change in the process. Hence, a corresponding switching status feedback is also generated on the "Switching" object such as in the case of cyclical telegrams for example.</p>
	<p>only if the feedback value changes</p>	<p>The actuator only updates the feedback value in the object if the telegram value (e.g. "OFF" to "ON") also changes. If the telegram value of the feedback does not change (e.g. in the case of cyclical telegrams to the "Switching" object with the same telegram value), the feedback then remains unchanged. Consequently, with an actively transmitting feedback object, no telegram with the same content will be transmitted repeatedly either.</p> <p>This setting is recommendable, for instance, if the "Switching" and "Switching feedback" objects are linked to an identical group address. This is often the case when activating by means of light scene push-button sensors (recall and storage function). This parameter is only visible in case of an actively transmitting feedback.</p>
<p>Time delay for feedback telegram after bus voltage return ?</p>	<p>Yes No</p>	<p>The feedback telegram can be transmitted to the bus with a delay after bus voltage return or after programming with the ETS. Setting "Yes" activates the delay time of the feedback in case of bus voltage return. The delay time is configured on the parameter page "General".</p> <p>This parameter is only visible in case of an actively transmitting feedback.</p>
<p>Cyclical transmission of the feedback ?</p>	<p>Yes No</p>	<p>The switching status feedback telegram can also be transmitted cyclically via the active message object in addition to the transmission after updating.</p> <p>Cyclical transmission is activated.</p> <p>Cyclical transmission is deactivated so that the feedback telegram is transmitted to the bus only when updated by the actuator.</p> <p>This parameter is only visible in case of an actively transmitting feedback.</p>

Feedback brightness value / speed ?	no feedback	The current brightness or speed value of the dimming channel can be signalled back separately to the bus.
	Feedback object is active signalling object	No feedback object is available for the brightness value or speed. Brightness value / speed feedback deactivated.
	Feedback object is passive status object	The "brightness value feedback" object or "feedback of speed" is enabled. The value is transmitted once this it updated. An automatic telegram transmission of the feedback takes place after bus voltage return or after programming with the ETS.
Updating the object value for brightness value / speed feedback	after each update obj. "brightness value" / obj. "speed"	You can specify here when the actuator should update the feedback value for the brightness value or speed in case of an actively transmitting communication object. The object value updated by the actuator is then signalled actively to the bus.
	only if the feedback value changes	The actuator updates the feedback value in the object once a new telegram is received on the input "brightness value / speed" object. With an actively transmitting feedback object, a new telegram is also then actively transmitted to the bus each time. The telegram value of the feedback does not necessarily have to change in the process. Hence, a corresponding brightness value feedback is also generated on the "brightness value / speed" object such as in the case of cyclical telegrams for example.
		The actuator only updates the feedback value in the object if the telegram value (e.g. "0 %" to "100 %") also changes. If the telegram value of the feedback does not change (e.g. in the case of cyclical telegrams to the "brightness value / speed" object with the same telegram value), the feedback then remains unchanged. Consequently, with an actively transmitting feedback object, no telegram with the same content will be transmitted repeatedly either. This setting is recommendable, for instance, if the "brightness value / speed" and "brightness value feedback /

		speed feedback" objects are linked to an identical group address. This is often the case when activating by means of light scene push-button sensors (recall and storage function). This parameter is only visible in case of an actively transmitting feedback.
Time delay for feedback telegram after bus voltage return ?	Yes No	The feedback telegram can be transmitted to the bus with a delay after bus voltage return or after programming with the ETS. Setting "Yes" activates the delay time of the feedback in case of bus voltage return. The delay time is configured on the parameter page "General". This parameter is only visible in case of an actively transmitting feedback.
Cyclical transmission of the feedback ?	Yes No	The brightness value/speed feedback telegram can also be transmitted cyclically via the active message object in addition to the transmission after updating. This parameter is only visible in case of an actively transmitting feedback. Cyclical transmission is activated. Cyclical transmission is deactivated so that the feedback telegram is transmitted to the bus only when updated by the actuator.
<input type="checkbox"/> Kx - Time delays		
Selection of time delay	no time delay Switch-on delay Switch-off delay ON delay and OFF delay	The "switching" communication object can be evaluated with a time delay. By this setting the desired function of the time delay is selected and the additional parameters of the delay enabled.
Switch-on delay Minutes (0...59)	0...59	This parameter is used for setting the duration of the switch-on delay. Sets the switch-on delay minutes.
Seconds (0...59)	0...10...59	Sets the switch-on delay seconds.
Switch-on delay retriggerable ?	Yes No	A switch-on delay still in progress can be retriggered (setting "Yes") by another "1" telegram. Alternatively, the retriggering time can be suppressed (setting "No").

		The parameters for the switch-on delay are only visible if switch-on delay or switch-on and switch-off delay are activated.
Switch-off delay Minutes (0...59)	0...59	This parameter is used for setting the duration of the switch-off delay.
		Sets the switch-off delay minutes.
Seconds (0...59)	0...10...59	Sets the switch-off delay seconds.
Switch-off delay retriggerable ?	Yes No	A switch-off delay still in progress can be retriggered (setting "Yes") by another "0" telegram. Alternatively, the retriggering time can be suppressed (setting "No").
		The parameters for the switch-off delay are only visible if switch-on delay or switch-on and switch-off delay are activated.
<input type="checkbox"/> Kx - Staircase function / K1 - Time dimmer function		
Staircase time / Time dimmer Hours (0...23)	0...23	This parameter is used for programming the duration of the staircase / time dimmer function.
		Switch-on time hours setting.
Minutes (0...59)	0...3...59	Switch-on time minutes setting.
Seconds (0...59)	0...59	Switch-on time seconds setting.
		i In the "speed controller" operating mode for the "1-gang" device variant the staircase function is called a "time dimmer function".
Staircase time / Time dimmer retriggerable ?	Yes No	An active switch-on time can be retriggered (setting "Yes"). Alternatively, the retriggering time can be suppressed (setting "No"). This parameter is preset to "No" if the supplementary function "Time extension" is configured. Re-triggering will not be possible.
Reaction to OFF- telegram		An active switch-on time can be aborted prematurely by switching off the staircase / time dimmer function.
	switch off	

		<p>The switch-on time is aborted after receipt of an OFF telegram on the object "Staircase time start/stop" / "Time dimmer start/stop".</p> <p>With the supplementary function "Time preset via the bus" and the setting "staircase function / time dimmer function via object 'staircase time' activatable ? = Yes", the switch-on time can also be prematurely ended by a factor of "0".</p>
	ignore	<p>OFF Telegrams or "0" factors are ignored. The switch-on time will be executed completely to the end.</p>
Supplementary function for staircase function / time dimmer function		<p>The staircase function can be extended by the two supplementary functions "time extension" and "time processes via bus", which should be used alternatively. The time dimmer function in the "speed controller" operating mode can optionally be supplemented by the "time processes via bus" only.</p> <p>This parameter enables the desired supplementary function and thereby activates the necessary parameters or objects.</p>
	no supplementary function	<p>No supplementary function is enabled.</p>
	Time extension	<p>The time extension is activated. This function permits retriggering an activated staircase lighting time span-times via the object "Staircase function start/stop".</p> <p>The "Time extension" supplementary function is not necessary in the "speed controller" operating mode for the "1-gang" device variant.</p>
	Time preset via the bus	<p>The time preset via the bus is activated. With this supplementary function, the configured switch-on time can be multiplied by a factor received via the bus, thus it can be adapted dynamically.</p>
Maximum time extension	1-fold time 2-fold time 3-fold time 4-fold time 5-fold time	<p>In case of a time extension (retriggering the lighting time n-times via the object "Staircase function start/stop"), the parameterized staircase lighting time will be extended by the value programmed in this parameter.</p> <p>"1-fold time" means that after the started staircase time has elapsed, it can be retriggered a maximum of one more time. The time is therefore extended two fold. The other settings behave in a similar manner.</p> <p>This parameter is visible only if the</p>

		supplementary function "time extension" is set.
Staircase function activatable via "Staircase time / Time dimmer" object ?	Yes No	A time preset via the bus can specify here whether the receipt of a new time factor also starts the switch-on time (setting "Yes"). At the same time, the object "Staircase function start/stop / "time dimmer start/stop" is hidden. If the setting is "No", the switch-on time can be activated exclusively via the object "Staircase function start/stop / "time dimmer start/stop". This parameter is visible only if the supplementary function "Time preset via the bus" is set.
Reaction at the end of the staircase time / time dimmer function		At the end of the switch-on time, the actuator for the dimming channel concerned displays the configured behaviour here. The channel can be set to switch off immediately, alternatively to execute the pre-warning function or to dim to a reduced continuous lighting (application: long, dark hallways), or to activate a continuous speed (e.g. basic ventilation).
	switch off	At the end of the switch-on time, the actuator switches off the dimming channel concerned. If the soft OFF function is configured, switching off takes place via a dimming procedure.
	activate pre-warning time	At the end of the switch-on time, the dimming channel can generate a pre-warning (reduction of brightness / speed) prior to switching off. The pre-warning, for example, should warn any person still on the staircase that the light will soon be switched off.
	activate reduced continuous lighting / activate reduced continuous speed (basic ventilation)	At the end of the switch-on time, the actuator activates the reduced continuous lighting / continuous speed for the dimming channel concerned. The reduction of the lighting to continuous lighting is appropriate, for example, if a certain degree of artificial light should be switched on permanently in long, dark hallways. Switching to switch-on brightness by activating the staircase function normally takes place by additional presence detectors or motion detectors when people are present in the hallway. The continuous lighting / continuous speed remains permanently active after the switch-on time has elapsed. Only when an ON telegram is received again

		via the object "Staircase function start/stop" / "Time dimmer start / stop" does the actuator switch back to the switch-on brightness/ switch-on speed and start counting the switch-on time again.
Pre-warning time Minutes (0...59)	0 ...59	This parameter is used for setting the duration of the pre-warning time. The pre-warning time is added to the switch-on time. The reduced brightness / speed is set during the time configured here.
Seconds (0...59)	0... 30 ...59	Sets the pre-warning time in minutes. Sets the pre-warning time in seconds. These parameters are visible only if the pre-warning function is enabled.
Reduced brightness / speed during the pre- warning time (1...100 %)	1... 50 ...100	This parameter defines the reduced brightness that is set for pre-warning. This parameter is visible only if the pre-warning function is enabled.
Reduced brightness / speed for continuous lighting / continuous speed (1...100 %)	1... 50 ...100	This parameter defines the reduced brightness or speed that is set for continuous lighting or continuous speed. This parameter is visible only if the continuous function is enabled.
		i The brightness or speed of the continuous lighting does not necessarily have to be less than the switch-on brightness / switch-on speed. These brightness values or speed values can always be configured to values in the defined dimming range.
<input type="checkbox"/> Kx - Switch-on/switch-off behaviour		
Soft ON function ?	Yes No	The soft ON function permits the dimming channel to be switched on more slowly. If this function (setting "Yes") is activated, a dimming procedure to the switch-on brightness is executed after receiving a switch-on telegram via the "switching" or "central switching" object. No soft ON function is possible for the "1-gang" device variant in the "speed controller" operating mode.
	0 ...59	

Time for soft ON dimming increment Seconds (0...59)		These parameters set the soft ON function for the dimming increment time.
Milliseconds (1...99 * 10)	1...99	Setting of the seconds of the dimming increment time for soft ON. Milliseconds setting of the dimming increment time for soft ON. The parameters for the soft ON function are visible only if the soft ON function is enabled.
Soft OFF function ?	Yes No	The soft OFF function permits the dimming channel to be switched off more slowly. If this function (setting "Yes") is activated, a dimming procedure to the brightness "0 %" is executed after receiving a switch-off telegram via the "switching" or "central switching" object.
Time for soft OFF dimming increment Seconds (0...59)	0...59	These parameters set the soft OFF function for the dimming increment time.
Milliseconds (1...99 * 10)	1...99	Seconds setting of the dimming increment time for soft OFF. Milliseconds setting of the dimming increment time for soft OFF. The parameters for the soft OFF function are visible only if the soft OFF function is enabled.
Automatic switch-off if a brightness / speed is undershot?	Yes No	The automatic switch-off function of the dimming channel can be activated here. If this function is activated, the connect load will switch off completely when a configurable brightness or speed is undershot at the end of a dimming procedure, and if necessary, after a delay time has elapsed.
Switch-off if brightness value / speed value is smaller than	5 % 10 % 15 % ... 95 % 100 %	This parameter defines the brightness or speed, which if undershot, will cause the dimming channel to be switched off at the end of a dimming procedure, or if necessary, after a delay time has elapsed. This parameter is only visible if the switch-off function is activated.
Delay time until switching off Hours (0...23)	0...23	This parameter sets the delay time of the switch-off function. If the switch-off brightness or speed is undershot at the

		end of a dimming procedure, the dimming channel is switched off after the time set here has elapsed.
		Setting the delay time hours.
Minutes (0...59)	0...59	Setting the delay time minutes.
Seconds (0...59)	0...30...59	Setting the delay time seconds.
		The parameters for the time delay are visible only if the switch-off function is enabled.
		i If the switch-off brightness was undershot because of a disabling or forced position function or the pre-warning function or continuous lighting of the staircase function, the switch-off function is not executed!
<input type="checkbox"/> Kx - Scenes		
Delay scene recall ?	Yes No	A scene is recalled via the scene extension object. If needed, the scene recall on the actuator can be made with a delay after reception of a recall telegram (setting: "Yes"). The recall is alternatively made immediately on reception of the telegram (setting: "No").
		i A recall delay has no influence on the storage of scene values.
Delay time Minutes (0...59)	0...59	This parameter is used for setting the duration of the scene delay time.
		Sets the scene delay time in minutes.
Seconds (0...59)	0...10...59	Sets the scene delay time in seconds.
		i The delay time parameters are only visible, if the parameter "Delay scene recall ?" is configured to "Yes".
Behaviour when recalling a scene	Jumping to brightness value / speed Dimming to brightness value / speed via dimming increment time Dimming brightness value via fading	When recalling a scene, the configured or stored scene value is set for the dimming channel concerned. This parameter setting can define whether the brightness value or speed can be instantly jumped to or dimmed to or is set via fading. When fading, the brightness value to be set is reached in the exact configured fading time

		irrespective of the dimming characteristic of a channel and irrespective of which brightness value the dimming procedure was started at. Thus, for example, several dimming channels can be set to the same brightness at the same time. It is not possible to dim a speed value via "fading" in the "speed controller" operating mode for the "1-gang" device version. Hence, this setting is not necessary in the operating mode mentioned.
Dimming increment time (0...255 ms)	0... 5 ...255	Setting of the dimming increment time if the brightness value / speed value of a scene should be dimmed. This parameter is visible only if the parameter "behaviour when recalling a scene" is set to "dim to brightness value / speed via dimming increment time".
Fading time (0...240 s)	0... 2 ...240	Setting of the fading time if the brightness value of a scene should be dimmed to via fading. This parameter is visible only if the parameter "behaviour when recalling a scene" is set to "dim to brightness value via fading".
Overwrite values stored in the device during ETS download ?	Yes No	During storage of a scene, the scene values (current states of the dimming channels concerned) are stored internally in the device. To prevent the stored values from being replaced during an ETS programming operation by the originally programmed scene values, the actuator can inhibit overwriting of the scene values (setting: "No"). As an alternative, the original values can be reloaded into the device during each ETS programming operation (setting: "Yes").
Scene X activatable by scene number (scene number "0" = scene deactivated) X = depending on the scene (1...8)	0... 1 *...64 *: The predefined scene number is dependent on the scene (1...8).	The actuator distinguishes between up to 8 different scenes which are recalled via the scene extension object or stored. The datapoint type of the extension object, however, permits addressing a maximum of 64 scenes. This parameter defines the scene number (1...64) which is used to address the internal scene (1...8). A setting of "0" deactivates the corresponding scene.

Brightness value / speed for scene X	switch off	This parameter is used for configuring the brightness value which is set when the scene is recalled. The "basic brightness" setting may only be configured if the dimmable brightness range is limited to the lower limit by the basic brightness "see parameter page "Kx - General)". Furthermore, this setting is not available in the "speed controller" operating mode. The preset value depends on the scene.
X = depending on the scene (1...8)	Basic level of brightness (if configured)	
	5 %	
	10 %	
	15 %	
	...	
	95 %	
	100 %	
Storage function for scene X	Yes	Setting "yes" enables the storage function of the scene. If the function is enabled, the current brightness value can be stored internally via the extension object on receipt of a storage telegram. If "no" is selected, the storage telegrams are rejected.
X = depending on the scene (1...8)	No	
<input type="checkbox"/> Kx - Operating hours counter		The operating hours counter can be enabled here. If the operating hours counter is not enabled in the configuration of a DALI group or a single device, no operating hours will be counted for the DALI group or single device concerned. Once the operating hours counter is enabled, however, the operating hours will be determined and added up by the ETS immediately after commissioning the DALI Gateway. If the operating hours counter is subsequently disabled again in the parameters and the Gateway is programmed with this disabling function, all operating hours previously counted for the DALI group or the single device concerned will be deleted. When enabled again, the counter status of the operating hours counter is always on "0".
Operating hours counter ?	no	
	yes	
Type of counter	Up-counter	The operating hours counter can be configured as an up-counter or down-counter. The setting here influences the visibility of the other parameters and objects of the operating hours counter.
	Down-counter	

Start/Limiting value presetting ?	<p>no</p> <p>yes, as received via object</p> <p>yes, as specified in parameter</p>	<p>If the down-counter is used, a start value can optionally be predefined. If the up-counter is used, a limiting value can optionally be predefined. This parameter defines whether the start or limiting value can be set via a separate parameter or adapted individually by a communication object from the bus. The setting "No" deactivates the start / limiting value.</p>
Start/limiting value (0...65535 hrs.)	0... 65535	<p>The start value of the down-counter or the limiting value of the up-counter is set here.</p> <p>This parameter is only visible if the parameter "Start / limiting value specification ?" is set to "Yes like the parameter".</p>
Automatic transmitting of the counter value	<p>cyclical</p> <p>after change by interval value</p>	<p>The current counter status of the operating hours counter can be transmitted actively to the bus via the "OHC value" communication object.</p> <p>The counter status is transmitted cyclically to the bus and when there is a change. The cycle time is generally configured in the parameter node "General -> Status and feedback".</p> <p>The counter status is transmitted to the bus only when there is a change.</p>
Counting value interval (1...65535 h)	1... 65535	<p>The interval of the counter value is set here for automatic transmission. The current counter status is transmitted to the bus after the time value configured here.</p> <p>This parameter is only visible if the parameter "Automatic transmission of the number value" is set to "Change on interval value".</p>
<p><input type="checkbox"/> Kx - Supplementary functions</p>		
Selection of supplementary function	<p>no supplementary function</p> <p>Disabling function</p> <p>Forced position</p>	<p>The supplementary function can be defined and enabled here. The disabling function is only configurable as an alternative to the forced position function.</p>
Polarity of the disabling object	<p>0 = disabled;</p> <p>1 = enabled</p> <p>1 = enabled;</p>	<p>This parameter defines the polarity of the disabling object.</p> <p>This parameter is visible only if the disabling function is enabled.</p>

	0 = disabled	
Behaviour at the beginning of the disabling function		The behaviour of the dimming channel at the beginning of the disabling function can be configured.
	switch off	At the beginning of the disabling function, the dimming channel is switched off and locked.
	Basic level of brightness (if configured)	At the start of the disabling function, the dimming channel is set to the predefined brightness value or to the set speed and locked (pay attention to configured minimum and maximum brightness!).
	5 %...100 %	The "basic brightness" setting may only be configured if the dimmable brightness range is limited to the lower limit by the basic brightness "see parameter page "Kx - General)". Furthermore, this setting is not available in the "speed controller" operating mode.
	Switch off memory value (brightness / speed before switching off the last time)	At the start of the disabling function, the active and internally saved value prior to switching off last time is set (via the "switching" or "central switching" object).
	No reaction	At the beginning of a disabling function, the dimming channel shows no reaction and remains in the current set state. Bus control of the dimming channel is then locked.
	Flashing	The dimming channel flashes on and off during the disabling function and the bus control is locked during this time. The flashing time is configured generally for all channels on the parameter page "General". During the flashing, the logical switching state is "on 1" and the switch-on brightness is signalled back as brightness. A soft ON/OFF function is ignored during flashing. The "flashing" setting is not available in the "speed controller" operating mode.
		This parameter is visible only if the disabling function is enabled.
		i The "flashing" setting cannot be selected in the "speed controller" operating mode for the "1-gang" device variant.
Behaviour at the end of the disabling function		The behaviour of the dimming channel at the end of the disabling function can be configured.
	switch off	

	At the end of the disabling function, the dimming channel is switched off and enabled again.
Basic level of brightness (if configured) 5 %...100 %	At the end of the disabling function, the dimming channel is set to the predefined brightness value or to the set speed and locked (pay attention to configured minimum and maximum brightness!). The "basic brightness" setting may only be configured if the dimmable brightness range is limited to the lower limit by the basic brightness "see parameter page "Kx - General)". Furthermore, this setting is not available in the "speed controller" operating mode.
Switch off memory value (brightness / speed before switching off the last time)	At the end of the disabling, the active and internally saved brightness / speed value prior to switching off last time is set (via the "switching" or "central switching" object).
tracked brightness value / tracked speed	At the end of the disabling, the state received during the disabling function or adjusted before the disabling function can be tracked with the appropriate brightness / speed value. Any time functions that are still in progress will also be taken into account if necessary.
No reaction	At the end of a disabling, the dimming channel shows no reaction and remains in the current set state. Bus control of the dimming channel is enabled again.
Flashing	The dimming channel is always enabled again for the bus control at the end of the disabling and flashes on and off. The flashing time is configured generally for all channels on the parameter page "General". During the flashing, the logical switching state is "on 1" and the switch-on brightness is signalled back as brightness. A soft ON/OFF function is ignored during flashing. The flashing status remains active until another bus command is received and specifies another status. The "flashing" setting is not available in the "speed controller" operating mode. This parameter is visible only if the disabling function is enabled.
Brightness / speed for forced position "active, switch on"	If the forced position is activated and forced-position state is "ON", you can define here how the dimming channel should behave.
Basic level of brightness (if configured)	The dimming channel is set to the predefined brightness value or speed (pay attention to configured

	5 %...100 %	minimum/maximum brightness!). The "basic brightness" setting may only be configured if the dimmable brightness range is limited to the lower limit by the basic brightness "see parameter page "Kx - General)". Furthermore, this setting is not available in the "speed controller" operating mode.
	Memory value (brightness / speed before switching off the last time)	The active and internally saved brightness / speed value prior to switching off last time is set (via the "switching" or "central switching" object).
	No reaction	The dimming channel shows no reaction and remains in the current set state. This parameter is only visible when the forced position function is enabled.
Brightness / speed for forced position "active, switch off"	0 %	If the forced position is activated and forced-position state is "OFF", the dimming channel is always switched off. This parameter cannot be edited. This parameter is only visible when the forced position function is enabled.
Brightness / speed for forced position end "inactive"	No reaction	The behaviour of the dimming channel at the end of the forced-position can be configured here. At the end of a forced position, the dimming channel shows no reaction and remains in the current set state. Bus control of the dimming channel is enabled again.
	tracked brightness value / tracked speed	At the end of a forced position, the state received during the forced position function or adjusted before the function can be tracked with the appropriate brightness value. Any time functions still in progress will also be taken into account if necessary. Bus control of the dimming channel is enabled again. This parameter is only visible when the forced position function is enabled.
Behaviour after bus voltage return	No forced position	The forced position communication object can be initialised after bus voltage return. The brightness status of the dimming channel can be influenced when the forced position function is activated. No forced position is activated after bus voltage return. Reaction of the dimming channel according to the parameter

		"Behaviour after bus or mains voltage return".
	Forced position active, switch on	The forced position is activated. The dimming channel is switched on to the brightness / speed value predefined by the parameter "switch on brightness / speed for forced position 'active'".
	Forced position active, switch off	The forced position is activated. The dimming channel is switched off under forced control.
	State before bus voltage failure	After bus voltage return, the state of the forced position is set as it was stored permanently at the time of the bus or mains failure. After programming the application or parameters with the ETS, the value is set internally to "not active". If the forced position is activated, the dimming channel is switched on to the brightness / speed value predefined by the parameter "switch on brightness / speed for forced position 'active'".
		This parameter is only visible when the forced position function is enabled.
Logic operation function ?	Yes No	This parameter can be used to enable the logic operation function (setting "Yes"). The parameter is preset to "No" if the staircase function / time dimmer function is enabled.
Type of logic operation function	OR AND AND with feedback	This parameter defines the logical type of the logic operation function. The object "logic operation" is linked to the logic switching state of the dimming channel (object "switching" after evaluation of configured time delays if necessary) using the logic operation function set here. This parameter is only visible when the logic operation function is enabled.
Object value of logic operation obj. after bus voltage return	0 (OFF) 1 (ON)	After bus voltage return, the object value of the logic operation object is initialised here with the preset value. This parameter is only visible when the logic operation function is enabled.
Object value of logic operation obj. after ETS download	0 (OFF) 1 (ON)	After programming the application or the parameters in the ETS, the object value of the logic operation object is initialised here with the preset value. This parameter is only visible when the

logic operation function is enabled.

☐ Kx - dimming characteristic

Characteristic curve

The dimming characteristic curve of the dimming channel can be set here. The lamp used can thus be adapted to the brightness sensitivity of the human eye.

linear

The brightness curve of basic brightness (decimal brightness value "1") up to 100 % (decimal brightness value "255") is linear.

adapted for incandescent lamps

The characteristic is adapted to incandescent lamp load.

adapted for halogen lamps

The characteristic is adapted to halogen lamp load.

user-defined

The brightness curve between basic brightness / minimum brightness and maximum brightness can be adapted individually. For this purpose, the brightness range is subdivided in up to three sections. Each section can be configured with an independent dimming speed.

i The settings "adapted for incandescent lamps" and "adapted for halogen lamps" cannot be selected in the "speed controller" operating mode for the "1-gang" device variant.

Time between two dimming increments (1...255 ms)

1...**10**...255

In the case of a linear characteristic curve, the dimming increment speed is set here (time between two dimming values).

1st area:
Time between two dimming increments (1...255 ms)

1...**20**...255

In the case of a user-defined characteristic curve, the dimming increment speed (time between two dimming values) of the first section is set here.
Only visible if "characteristic curve = "user-defined"!

Brightness / speed limiting value
1st area / 2nd area (1...100 %)

1...**20**...100

The first brightness / speed limiting value is parameterised here. This limiting value defines the boundary between the first and second section.
Only visible if "characteristic curve = "user-defined"!

2nd area: Time between two dimming increments (1...255 ms)	1... 10 ...255	In the case of a user-defined characteristic curve, the dimming increment speed (time between two dimming values) of the second section is set here. Only visible if "characteristic curve = "user-defined"!"
Brightness / speed limiting value 2nd area / 3rd area (1...100 %)	1... 80 ...100	The second brightness / speed limiting value is parameterised here. This limiting value defines the boundary between the second and third section. Only visible if "characteristic curve = "user-defined"!"
3rd area: Time between two dimming increments (1...255 ms)	1... 5 ...255	In the case of a user-defined characteristic curve, the dimming increment speed (time between two dimming values) of the third section is set here. Only visible if "characteristic curve = "user-defined"!"

- i** When setting the brightness limiting value, care must be taken to ensure that the values are greater than a configured minimum brightness, if necessary, and less than the set maximum brightness! When setting the speed limiting values, the minimum speed must be observed!

FELLER AG | Postfach | CH-8810 Horgen
Telefon +41 44 728 72 72 | Telefax +41 44 728 72 99

FELLER SA | Caudray 6 | CH-1020 Renens
Téléphone +41 21 653 24 45 | Téléfax +41 21 653 24 51

Service Line | Telefon +41 728 74 74 | info@feller.ch | www.feller.ch



by Schneider Electric