

**Schneider Electric Industries SAS**  
 35, rue Joseph Monier  
 92500 Rueil-Malmaison, France  
[www.schneider-electric.com](http://www.schneider-electric.com)

**ENGLISH**

This product must be installed, connected and used in compliance with applicable standards and/or installation regulations. As standards, specifications and designs develop from time to time, always ask for confirmation of the information given in this publication.

**DANSK**

Produktet skal installeres, tilsluttes og anvendes i henhold til gældende standarder og installationsregler. Få altid bekræftet, om oplysningerne i dette dokument stadig er gældende, da specifikationer, standarder og design ændres løbende.

**SVENSKA**

Denna produkt måste installeras, anslutas och användas i enlighet med gällande standarder och installationsföreskrifter. Eftersom standarder, specifikationer ändras med tiden, kontrollera att uppgifterna i denna publikation är aktuella mot gällande standarder.

**NEDERLANDS**

Dit product moet geïnstalleerd, aangesloten en gebruikt worden in overeenstemming met de geldende normen en/of installatievoorschriften. Omdat de normen, specificaties en modellen kunnen evolueren in de tijd, altijd vragen om bevestiging van de informatie in deze publicatie.

# Actassi 19-C 19" Copper panels

BBV12976-04

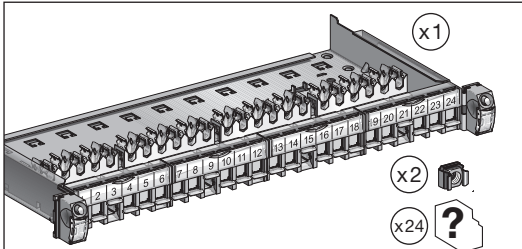

<b>VDIG111241U50</b>	Cat. 5e UTP	
<b>VDIG111241B50</b>	Cat. 5e STP	
<b>VDIG111241U60</b>	Cat. 6 UTP	
<b>VDIG111241B60</b>	Cat. 6 STP	
<b>VDIG111241UX0</b>	Cat. 6 <sub>A</sub> UTP	
<b>VDIG111241BX0</b>	Cat. 6 <sub>A</sub> STP	
<b>VDIG111241U</b>	UTP	
<b>VDIG111241F</b>	STP	

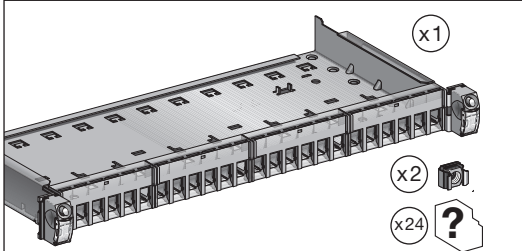

<b>VDIG011241U50</b>	Cat. 5e UTP	
<b>VDIG011241B50</b>	Cat. 5e STP	
<b>VDIG011241U60</b>	Cat. 6 UTP	
<b>VDIG011241B60</b>	Cat. 6 STP	
<b>VDIG011241BX0</b>	Cat. 6 <sub>A</sub> STP	
<b>VDIG011241U</b>	UTP	
<b>VDIG011241F</b>	STP	

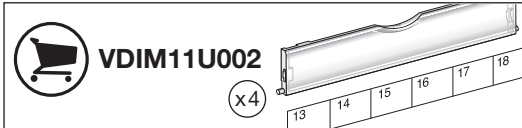
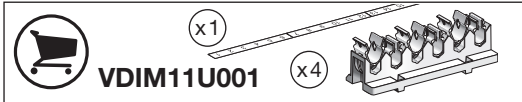
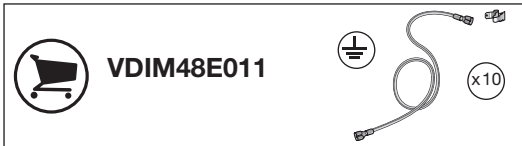

July V2 2012

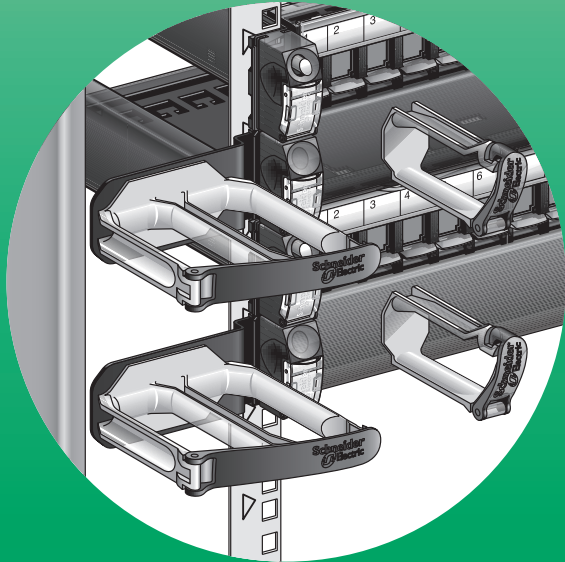
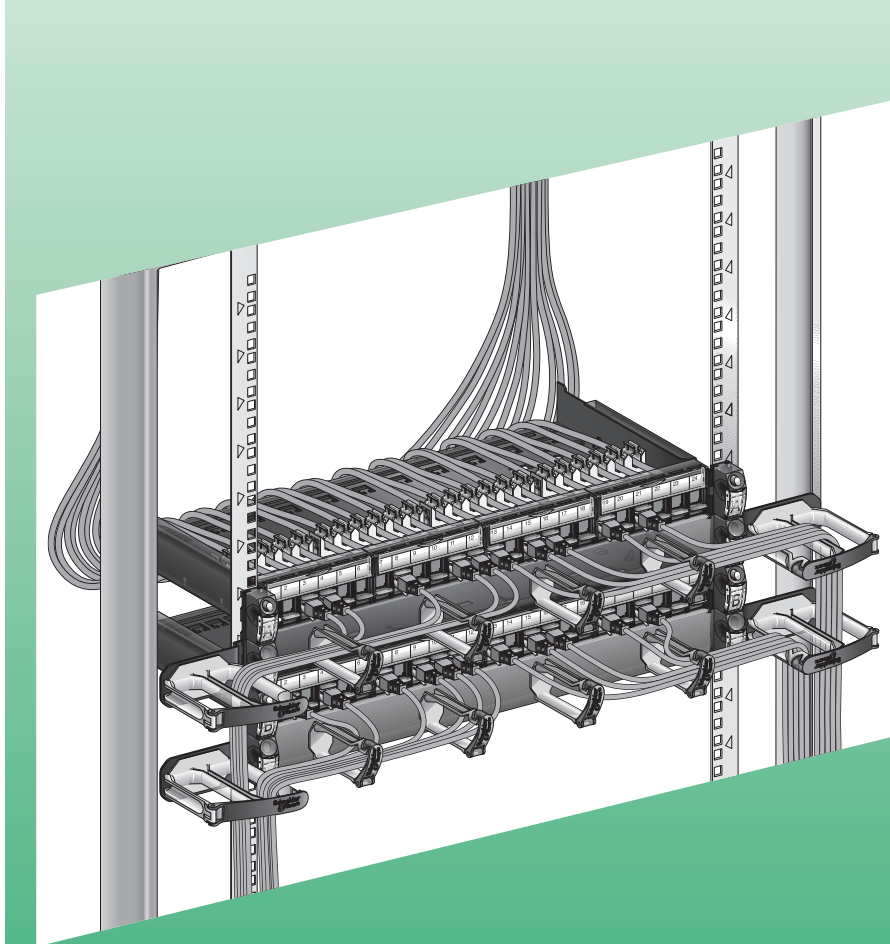

**A**