





















# ÜBERSICHT DIMMERSORTIMENT

	Universal (RLC)			Phasenanschnitt (RL)		Phasenabschnitt (RC)		1-10V	DALI
									
Bezeichnung	Drehdimmer	Drehdimmer	Drehdimmer	Drehdimmer	Drehdimmer	Drehdimmer	Drehdimmer	Drehdimmer	Drehdimmer
Beleuchtbar mit LED	●	●	●	●	-	●	●	-	-
Leistung	4-400W	20-420W/VA	20-600W/VA	40-600W	60-1000W	20-300VA	20-600VA	1-10V, max. 600VA	bis zu 25 EVG
Sicherung elektronisch	●	●	●	-	●	●	●	-	●
Min. Einstellung	●	●	●	●	●	●	●	●	●
Max. Einstellung	●	●	●	-	-	-	-	●	●
Schema 3	●	●	●	●	-	●	●	-	-
<b>EDIZIOdue Fertigapparate weiss, beleuchtet</b> (.xx siehe «Farbübersicht LED»)									
Artikelnummer Feller	40200.LED.FMI.61.xx	40420.RLC.FMI.61.xx	40600.RLC.FMI.61.xx	40600.RL.FMI.61.xx	-	40300.RC.FMI.61.xx	40600.RC.FMI.61.xx	-	-
Einheitsnummer	E No 548 832 6xx	E No 548 250 6xx	E No 548 240 6xx	E No 548 260 6xx	-	E No 548 290 6xx	E No 548 270 6xx	-	-
für alle anderen Farben Baukasten beleuchtet									
Artikelnummer Feller	40200.LED.BSM.xx	40420.RLC.BSM.xx	40600.RLC.BSM.xx	40600.RL.BSM.xx	-	40300.RC.BSM.xx	40600.RC.BSM.xx	-	-
Einheitsnummer	E No 548 833 7xx	E No 548 253 7xx	E No 548 243 7xx	E No 548 263 7xx	-	E No 548 293 7xx	E No 548 273 7xx	-	-
<b>EDIZIOdue Fertigapparate weiss, unbeleuchtet</b>									
Artikelnummer Feller	40200.LED.FMI.61	40420.RLC.FMI.61	40600.RLC.FMI.61	40600.RL.FMI.61	31000.FMI.61	40300.RC.FMI.61	40600.RC.FMI.61	40600.1-10V.FMI.61	40080.FMI.61
Einheitsnummer	E No 548 832 000	E No 548 250 000	E No 548 240 000	E No 548 260 000	E No 548 732 000	E No 548 290 000	E No 548 270 000	E No 548 280 000	E No 548 502 000
<b>Standard Fertigapparat weiss, unbeleuchtet</b>									
Artikelnummer Feller	40200.LED.PMI.61	40420.RLC.PMI.61	40600.RLC.PMI.61	40600.RL.PMI.61	31000.PMI.61	40300.RC.PMI.61	40600.RC.PMI.61	40600.1-10V.PMI.61	40080.PMI.61
Einheitsnummer	E No 348 836 000	E No 348 250 000	E No 348 240 000	E No 348 260 000	E No 348 730 000	E No 348 290 000	E No 348 270 000	E No 348 280 000	E No 348 609 000
<b>FLF Fertigapparat weiss, unbeleuchtet</b>									
Artikelnummer Feller	40200.LED.FLF.6/5.61	40420.RLC.FLF.6/5.61	40600.RLC.FLF.6/5.61	40600.RL.FLF.6/5.61	31000.FLF.6/5.61	40300.RC.FLF.6/5.61	40600.RC.FLF.6/5.61	40600.1-10V.FLF.6/5.61	40080.FLF.6/5.61
Einheitsnummer	E No 428 832 000	E No 428 675 000	E No 428 676 000	E No 428 672 000	E No 428 652 000	E No 428 674 000	E No 428 673 000	E No 428 620 000	E No 428 609 000
<b>Last/Verbraucher</b>									
Last								-	-
R 	●	●	●	●	●	●	●	-	-
L 	●	●	●	●	●	-	-	-	-
C 	●	●	●	-	-	●	●	-	-
mit EVG 	-	-	-	-	-	-	-	● mit EVG für 1-10V	● mit DALI-EVG
mit LED	●*	●*	●*	●*	●*	●*	●*	-	-

**Beispiel:**  
Zusammenstellung EDIZIOdue  
LED-Universaldrehdimmer 400VA sand  
mit LED weiss

Einsatz Baukasten beleuchtet, weiss (14)



40200.LED.BSM.14  
548 833 700



Abdeckset beleuchtbar, sand (36)







920-40000.FMI.SL.36  
378 343 810



Fertigapparat beleuchtet



**Symbolerklärungen**

-  Hochvolt-Halogenlampen und Glühlampen mit ohmscher Last
-  Niedervolt-Halogenlampen mit gewickeltem Transformator und induktiver Last
-  Niedervolt-Halogenlampen mit elektronischem Transformator und kapazitiver Last
-  LED-Lampen

\* Laut Feller DIMM-Tool: [www.feller.ch/dimmtool](http://www.feller.ch/dimmtool)

## Hinweis

Aufgrund fehlender Normen kann Feller den einwandfreien Betrieb von dimmbaren LED- und Sparlampen nicht garantieren. Bei einer möglichen Beschädigung von Dimmer oder Leuchtmittel lehnt Feller jede Haftung ab.

Bitte Feller DIMM-Tool unter [www.feller.ch/dimmtool](http://www.feller.ch/dimmtool) konsultieren.

Steckdosen sollten nicht mittels Dimmer angesteuert werden!

## Farbübersicht LED

	Feller Code	E No. Code
blau	..74	..70
weiss	..14	..00
gelb	..34	..80
rot	..44	..50
grün	..84	..60

## Einsetzen der Beleuchtungsgruppe

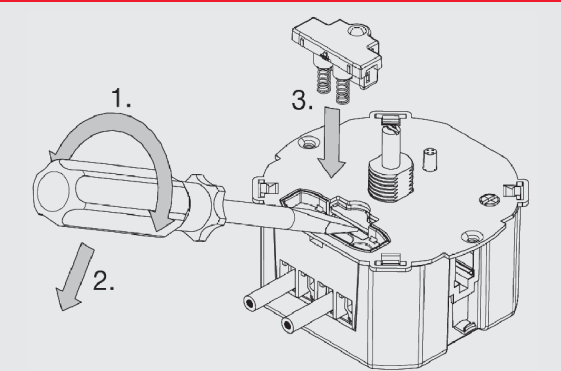

## Übersicht LED-Beleuchtungsgruppe

	Feller Nr.	E No.
blau	660.230V.LED.70	209 990 670
weiss	660.230V.LED.10	209 990 600
gelb	660.230V.LED.30	209 990 680
rot	660.230V.LED.40	209 990 650
grün	660.230V.LED.80	209 990 660

## Übersicht beleuchtbare Abdecksets

	Feller Nr.	E No.
weiss	920-40000.FMI.SL.61	378343000
silver	920-40000.FMI.SL.08	378343840
hellgrau	920-40000.FMI.SL.65	378343030
dunkelgrau	920-40000.FMI.SL.67	378343040
schwarz	920-40000.FMI.SL.60	378343950
vanille	920-40000.FMI.SL.37	378343080
crema	920-40000.FMI.SL.35	378343010
sand	920-40000.FMI.SL.36	378343810
coffee	920-40000.FMI.SL.57	378343890
lemon	920-40000.FMI.SL.88	378343860
olive	920-40000.FMI.SL.80	378343850
berry	920-40000.FMI.SL.41	378343800

**Feller**  
by Schneider Electric

Feller AG | Postfach 1 | CH-8810 Horgen  
Telefon +41 44 728 72 72 | Telefax +41 44 728 72 99 | [www.feller.ch](http://www.feller.ch)

Feller SA | Agence Suisse Romande | Caudray 6 | CH-1020 Renens  
Téléphone +41 21 653 24 45 | Telefax +41 21 653 24 51

69\_DIMMERUEB-D\_1504